

Installation Manual

Battery Energy Storage System

Soluna S8 EU-A50

DLG Energy (Shanghai) Co., Ltd.

June 2020 Version V1.1

About this manual

This manual describes how to install the SOLUNA Battery Energy Storage System (referred to as BESS from hereon), the Soluna S8 EU-A50, manufactured by DLG Energy (Shanghai) Co., Ltd.

Please read this manual before you attempt to install the product, and follow the instructions throughout the installation process. If you are uncertain about any of the requirements, recommendations, or safety procedures described in this manual, contact DLG Energy (Shanghai) Co., Ltd. immediately for advice and clarification.

The information included in this manual is accurate at the time of publication. Regarding the product design and technical specification updates, our company reserves the right to make changes at any time without prior notice. Also, the illustrations in this manual are intended to help explain system configuration concepts and installation instructions. The illustrated items may differ from the actual products at the installation location

Please search the products sections of the websites www.soluna.com.au or www.solunabattery.com to confirm that you are reading the latest version of the Installation Manual. Please search for the Australian version.

Version Information

Version	Date	Content	Author
V1.0	21 st May 2020	First edition	Henry
V1.1	1 June 2020	Contact details changed to solunabattery.com	Henry

Contents

Safety precautions	4
Warning signs	5
Safety guide	6
Transportation and installation	7
Grid-tied operation	8
Maintenance and replacement	8
What to do at the battery end of life	8
Product Introduction.....	9
Features.....	9
Application	9
Outline Dimensions	10
Functional description	11
Working modes	12
ALWAYS CHECK THE AS4777.2: 2015 SETTINGS WITH THE LOCAL GRID OPERATOR	13
Technical Data	16
Technical data of System.....	16
Technical data of battery module	17
Appearance.....	19
Installation	22
Installation tools.....	22
Spacing during installation and subsequent operation.....	23
Wiring specifications.....	24
Installation step	24
Unpacking confirmation	24
Basic installation requirement.....	25
Installation procedures.....	26
Step 1	26
Step 2:.....	27
Step 3.....	28
Step 4:.....	29
Step 5.....	30
Step 6.....	31
Step 7 :.....	34
How to operate Soluna S8 EU-A50.....	36
Turn on or turn off the Soluna S8 EU system.....	36
How to operate the LCD.....	37
The LCD is operated by touch, to view the information in the LCD simply touch to view the details.....	37
How to check the information on the LCD screen.....	38
How to Setting parameters of Soluna system	40
How to check the information of “Data” icon.....	44
How to check the production information of Soluna system	45
How to maintain.....	47
Fault handling	47
Remote monitoring	49
Contact us	60

Safety precautions

BESS are designed and tested following relevant international safety standards. As an electrical and electronic device, all applicable safety regulations must apply during installation, operation, and maintenance. Incorrect use or misuse may result in:

- Injury to the life and personal safety of the operator or other people.
- Damage to the system or other property belonging to the operator/other people.

This chapter mainly reviews various warning symbols in the operation manual and provides safety instructions for the installation, operation, maintenance and use of the BESS .





Statement

Our company shall not be liable for any consequence caused by any of the following events.







- Damage caused by transportation.
- The storage conditions do not meet the requirements specified in the manual, resulting in damage.
- Incorrect storage, installation, and use.
- Unqualified personnel install and operate the system.
- Failure to comply with the operation instructions and safety precautions in this manual.
- Operation in extreme environments which are not covered in this manual.
- Exceed the operation range of parameters specified in the technical specification.
- Unauthorized disassembly, modification, or modification of the software code.
- Device damage caused by abnormal natural environment (force majeure, such as lightning strikes, earthquakes, fires, storms, etc.)
- Warranty expiration.
- Installation or use in an environment which is not specified in the related international standards

Warning signs

Warning signs are used to warn you about the conditions that may cause severe injury or damage to the device. They instruct you to exercise caution to prevent danger. The following table describes the warning signs used in this manual.

Sign	Name	Description
	Danger	Severe physical injury or even death may occur if related requirements are not followed
	Warning	Physical injury or damage to the devices may occur if related requirements are not followed.
	Electrostatic discharge	Damage may occur if related requirements are not followed
	Hot sides	Sides of the device may become hot. Do not touch.
Note	Note	Steps to take for ensuring the proper running of the device.

Safety guide

	<p>After receiving this product, first, confirm the product package is intact. If any question, contact the logistic company or local distributor immediately.</p> <p>The installation and operation of the system must be carried out by professional technicians. They have received professional training, and thoroughly familiar with all the contents in this manual and the safety requirements of the electrical system.</p> <p>Do not carry out connection/disconnection, unpacking inspection and unit replacement operations on the system when the power source is applied.</p> <p>Before wiring and inspection, users must confirm the breakers on DC and AC side of the inverter are disconnected and wait for at least 5 mins</p>
	<p>Ensure there is no substantial electromagnetic interference caused by other electronic or electrical devices around the installation site.</p> <p>Do not refit the system unless authorized.</p> <p>All the electrical installation must conform to local and national electrical standards.</p> <p>Ground with proper technics before the operation</p>
	<p>Do not open the surface cover of the system unless authorized. The electronic components inside the system are electrostatic sensitive. Do take proper anti-electrostatic measures during authorized operation.</p>
	<p>Do not touch the housing of the system or the radiator to avoid scald as they may become hot during operation</p>
	<p>The system needs to be reliably grounded.</p>
	<p>Ensure that DC and AC side circuit breakers have been disconnected and wait at least 5 minutes before wiring and checking.</p>
<p>Note: Technical personnel who can perform installation, wiring, commissioning, maintenance, troubleshooting and replacement of the energy storage inverters must meet the following requirements:</p> <ul style="list-style-type: none"> • Operators need professional training and should wear the recommended PPE. • Operators must read this manual thoroughly and understand the related safety precautions. • Operators need to be familiar with the relevant safety regulations for electrical systems in the region of the installation. • Operators need to be fully aware of the composition, operating principle of the entire energy storage system, and related standards in the region of the installation. 	

Transportation and installation



- Keep the package and unit complete, dry and clean during storage and transportation.
- Please remove and install it with at least two people.
- To ensure the safe operation of the BESS and avoid personal injury, please select proper handling and installation tools, and take mechanical protection measures to PPE, such as wearing steel toe capped shoes, overalls and so on.
- Only qualified electricians are allowed to install the system.
- Do not put and install the system on or close to flammable or explosive materials.
- Do not install the system in a place where children and other people can easily touch it.
- To avoid the risk of electric shock, please remove rings, bracelets, and other metal jewellery on your hands before installation and electrical connection.
- The solar cell modules exposed to the sunlight may generate a dangerous voltage. Users must cover the cell modules with sufficiently light shading materials before electrical connection.
- The input voltage of the system should not exceed the maximum input voltage. Otherwise, damage may occur.
- The system is not suitable for the positive or negative grounding systems of solar cell modules.
- Ensure the proper grounding of the inverter.
- Ensure a reliable installation and electrical connection.

Grid-tied operation

Note	<ul style="list-style-type: none">• Only qualified electricians are allowed to operate the system under the permission of local power departments.• All electrical connections must meet the electrical standards of the countries/regions where the installation is happening.• Ensure a reliable installation and electrical connection before operation.• Do not open the cover when the system is working or any circuit is connected to the system.
-------------	---

Maintenance and replacement

	<ul style="list-style-type: none">• Only qualified electricians are allowed to perform the maintenance, inspection, and component replacement of the system.• Please contact the distributor or manufacturer for support.• To avoid irrelevant personnel from entering the maintenance area during maintenance, temporary warning signs must be placed to warn non-professionals not to enter. Use a fence for isolation.• Before carrying out any maintenance operations, all input power to the system must be disconnected first, and wait for at least 5 minutes until the internal parts of the system have fully discharged.• Please follow the electrostatic protection norms, and take correct protective measures because there are mostly electrostatic-sensitive circuits and devices in the system.• Do not use parts and components not provided by our company during maintenance.• Restart the system after eliminating the faults and problems which may affect the safety and performance of the system.• Do not get close to or touch any charged metal conductor parts of the Grid or running system; otherwise, electric shock or fire may occur. Please do not ignore the warning icons and instructions with “electric shock”.
---	---

What to do at the battery end of life

	<ul style="list-style-type: none">• Do not dispose of the system together with household waste. The user is responsible and obliged to send it to a designated organization for recycling and disposal. Seek advice from Soluna Australia,
---	--

Product Introduction

Soluna's S8 EU-A50 can connect with a solar power generation system, assisting the customer to use environmentally-friendly energy 24 hours per day. The BESS can store the energy generated by the PV, using it when required, reducing electricity bills, improving the household energy self-consumption and working when there is a BLACKOUT. A Soluna BESS will provide the solution.

Features

- Intelligent power management
- Simple user controls, power data history analysis, and programming
- Touch-screen LCD interface
- Secure battery access door
- Height-adjustable threaded appliance-grade feet for stability and level appearance

Application

- Self-use
- Peak Shaving
- Emergency power

Outline Dimensions

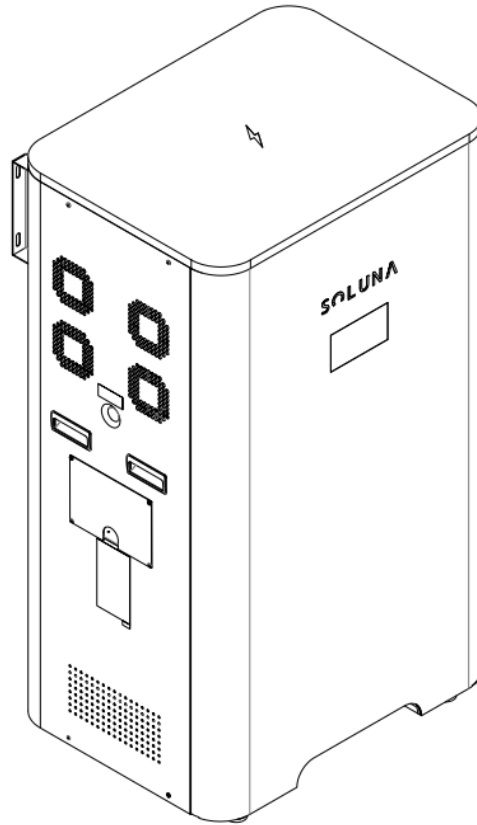

Figure 2.1 outline dimension

Width	750	mm
Depth	565	mm
Height	1335	mm
Weight	240	kg

Functional description

The basic principle of Soluna S8 EU-A50

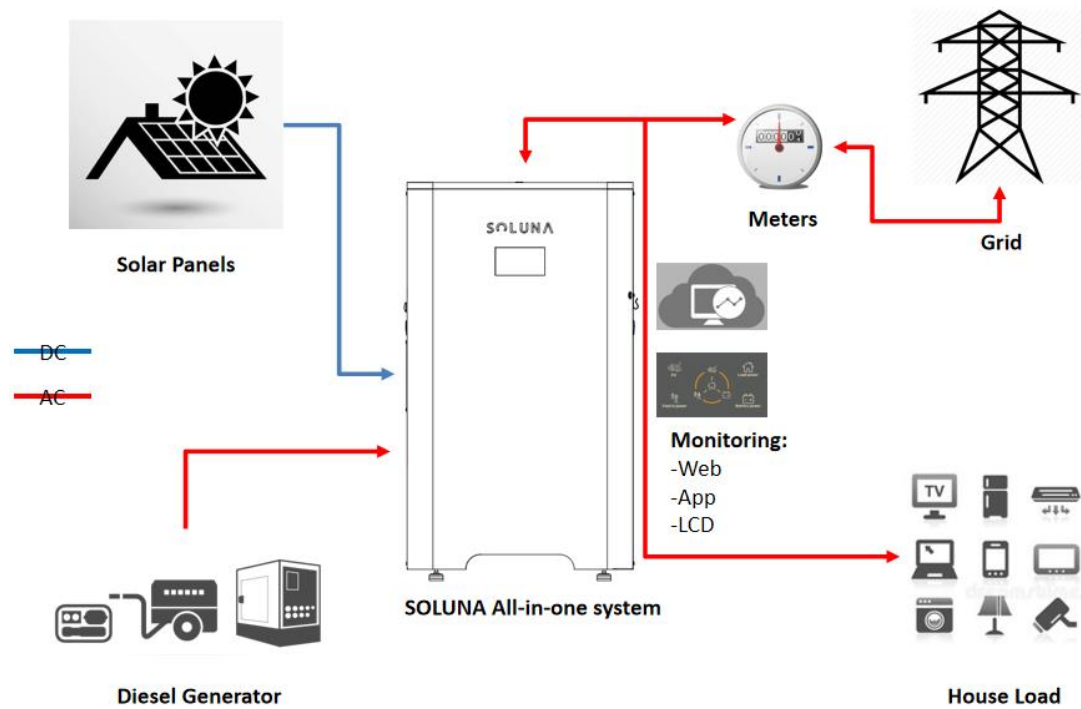

Figure2.2 basic principle of Soluna S8 EU

Working modes

Soluna's S8 EU-A50 have the working modes (see below):

- Mode 1:** In the daytime, the PV power will charge the battery as a priority, if the battery is full, the PV power is used to power the loads, then finally excess energy is sold to the Grid.
- Mode 2:** At night time, the battery power the loads, if the battery is not sufficient, the Grid will supplement.
- Mode 3:** If there is a Grid failure or in an off-Grid region, the PV and battery can power the loads together.
- Mode 4:** When the battery is low, and the PV power is unavailable, the Grid can charge the battery, and at the same time, the Grid will also power the loads.
- Mode 5:** A generator can charge the battery bank.
- Mode 6:** If the Time-of-Use function is enabled, it will ensure the remaining battery power is used during peak times.
- Mode 7:** The UPS Function can ensure essential loads still powered should the Grid fail unexpectedly.

Active power and reactive power setting

The Soluna BESS is capable of producing reactive power and feeding it into grid through the setting. Feeding in management can be controlled directly by the grid company through a dedicated communication port.

Volt-Var Response Mode

The Soluna BESS series complies with AS/NZS 4777.2: 2015 standard which introduced the voltage-var response mode to restrict the power output of the inverter in response to the voltage at its terminals (refer to AS/NZS 4777.2: 2015).

This mode is not enabled by default and when activated, it will sink reactive power in response to an increasing voltage (inductive) and supply reactive power in response to a decrease in voltage (capacitive). The voltage at which the inverter should sink/supply a reactive power at a given % of the VA rating of the inverter can be adjusted, the default values are given in the table below.

ALWAYS CHECK THE AS4777.2: 2015 SETTINGS WITH THE LOCAL GRID OPERATOR

Adjusting Volt-Var mode settings

Click Q(V) icon and set V1~V4, Q1~Q4 to comply with the local Grid.

<i>Parameters</i>	<i>Explanation</i>	<i>Default (Reference value: Vac)</i>
V1	Grid voltage	207
V2	Grid voltage	220
V3	Grid voltage	250
V4	Grid voltage	265

Parameters	Explanation	Default (Reference value)
Q1	Var % rated VA	0.3
Q2	Var % rated VA	0
Q3	Var % rated VA	0
Q4	Var % rated VA	-0.3

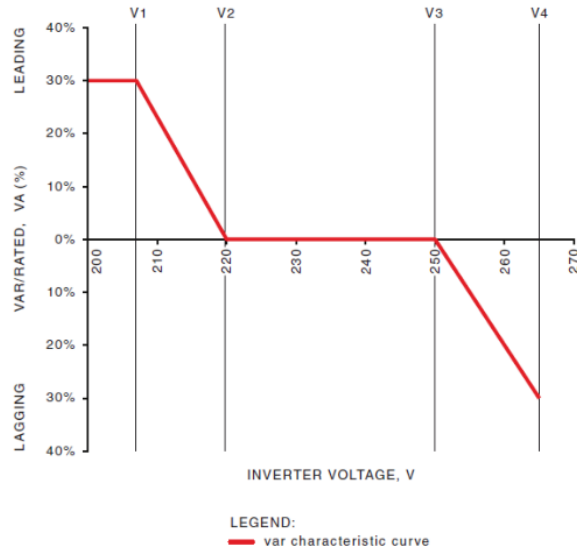

Volt-Watt Response Mode

The Soluna BESS series complies with AS/NZS 4777.2: 2015 standard. The grid voltage at which the inverter output starts to drop/de-rate is set to 250 V by default as required by the standard. This means that when the grid voltage exceeds 250 V, the maximum output of the inverters will be restricted (as required by the standard). The maximum output decreases by approximately 5 % for every volt beyond 250 V, down to 20% of the nominal output when the voltage reaches 265 V. For example, if setting Vstart=250V and Vstop=265V. When the grid voltage reaches 250V and gradually increases to 265V, the inverter output power will gradually decrease. When the voltage reaches to 265V, its output power will decrease to 20% of Pstart.

This mode is not enabled by default and will reduce the output power of the inverter in response to an increasing voltage at the AC terminals of the inverter. The voltage that the inverter produces a given % of the VA rating of the inverter can be adjusted via the LCD on the front of the Soluna system.

Adjusting Volt-Watt mode settings

Click VW icon and set Vstart and Vstop to comply with the local Grid.

AS4777.2 Voltage reference	Soluna system Voltage reference	AS4777.2 Power reference	Soluna system Power reference	AS4777.2 (default value)
V1	-	P/Prate%@V1	-	100%
V2	-	P/Prate%@V2	-	100%
V3	Vstart voltage (V)	P/Prate%@V3	Vstart Power	100%
V4	Vstop voltage (V)	P/Prate%@V4	Vstop Power	20%

BLACK TEXT= AS4777.2 TERMS

BLUE TEXT= EQUIVALENT

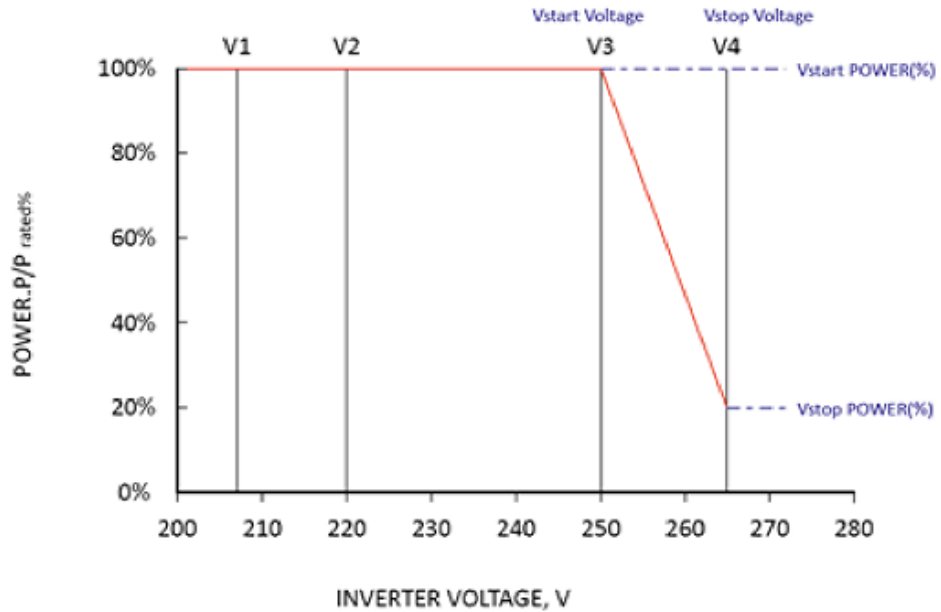

Remark:

User can find the QV & VM icon in reset & advanced setting icon on the LCD), Please find the following picture for details.

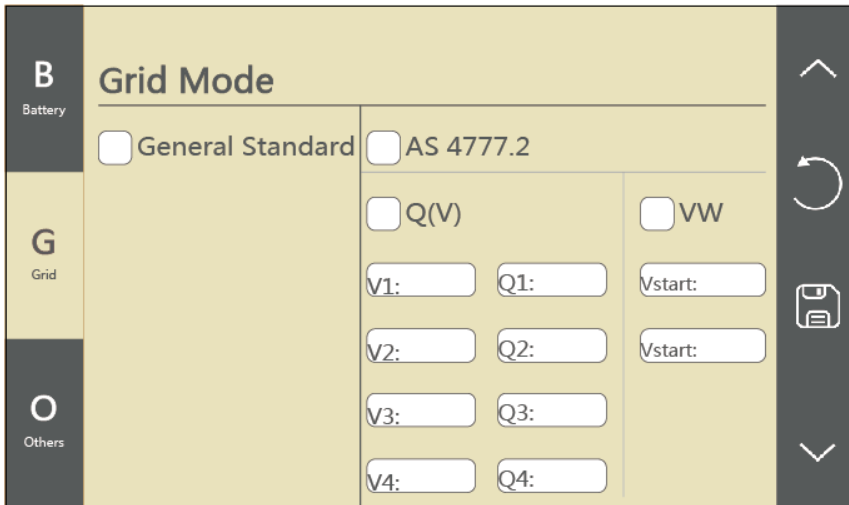

DRMs, logic interface for AS/NZS 4777.2:2015, is used to receive and response commands from grid company and then adjust inverter output power.

The Earth fault alarm

Before the inverter starts to connect to the grid, the inverter will first detect the impedance of PV + to ground, and the impedance of PV- to ground. If any of these impedance values is less than 33 kΩ, the inverter will not connect to the grid and will report an error (DC Insulation Impedance Fault) on its LCD.

Technical Data

Technical data of System

PV input	
Max. recommended DC power (W)	6500
Max. DC voltage (V)	500V
Isc PV (absolute Max.) (A)	16A/16A
Number of MPPT trackers	2
Strings per MPPT tracker	1/1
Nominal DC operating voltage (V)	360
Max. input current (A)	11A/11A
MPPT voltage range (V)	125-425
Vdc range @ full power (Vdc)	250-425
AC Input & AC Output	
Normal Voltage (VAC)	230,Single phase(L/N/PE)
Frequency (Hz)	50
Max. AC output current (A)	25A
Max. AC input current (A)	25A
Max. continuous Power (kW)	5kW
Power factor range	-0.8~+0.8
Off-Grid AC Output	
Normal Voltage (VAC)	230,Single phase(L/N/PE)
Frequency (Hz)	50Hz
Max. AC output current (A)	25A
Max. continuous Power (kW)	5kW
Power factor range	-0.8~+0.8
Inverter Efficiency	
Max.Efficiency	97.60%
Euro.Efficiency	96.50%
MPPT.Efficiency	99.90%
Battery data	
Battery Type	LFP
Module number	2
Nominal Storage capacity (kWh)	7.68
Usable Storage Capacity (kWh)	6.14
Battery capacity (Ah)	150
Normal voltage (V)	51.2
Voltage range (V)	42-58
Max. charge current (A)	100
Max. discharge current (A)	100
DOD	80%

Cycle life	6000
Regular parameters	
Protective class	Class I
Overvoltage category	OVC II(PV) , OVCIII(AC main Grid)
Dimension (mm)	W*D*H=750*565*1335
Weight (kg)	240
Display	7" graphic LCD
Communication	WIFI, CAN
Operating temperature range (°C)	-10~+40
Storage stability range (°C)	-20~+60
Relative humidity	0~95%
Altitude (m)	<2000
Cooling methods	Forced airflow
Ingress protection	IP20
Condition	Indoor conditioned
Certificates	IEC62109 CE-LVD EN 62477-1: 2012+ALL: 2014
Warranty	
Please refer to SOLUNA WARRANTY CONDITIONS	

Technical data of battery module

Physical Characteristics	
Width	205 mm
Depth	678 mm
Height	436 mm
Weight	60 kg
Electrical Characteristics	
Battery type	LFP
Total Energy Capacity	3.84 kWh
Usable Energy Capacity	3.07 kWh
Battery Capacity	75 Ah
Voltage Range	40~58.4 V
Nominal Voltage	51.2 V
Charge / Discharge current (Nominal)	19A / 38A
Max. Charge / Discharge Current	50A / 50 A
Max. Charge / Discharge Power	2.5 kW
DOD	80%
Internal resistance	≤60 mΩ
Cycle life	≥6000
Battery Pack Round-Trip Efficiency	>95%
DC Disconnect	Contacteur Fuse

BMS	
Power consumption	<3W (work), <100mW (sleep)
Monitoring parameters	System Voltage
	System Current
	Cell Voltage
	Cell temperature
Communication	CAN
System Configuration	
Module parallel	1~4 Parallel
Operating Conditions	
Installation Location	Indoor
Operating Temperature	-10~45 °C
Operating Temperature (Recommended)	15~30 °C
Storage Temperature	-20~60 °C
Humidity	5%~95%
Altitude	Max. 2,000 m
Cooling Strategy	Natural Convection
Reliability & Certification	
Certificates	Cell: UL1642
Hazardous Materials Classification	Battery Module: IEC62619 / UL1973
Transportation	UN38.3
Ingress Rating	IP20
Warranty	
Please refer to SOLUNA WARRANTY CONDITIONS	

Appearance

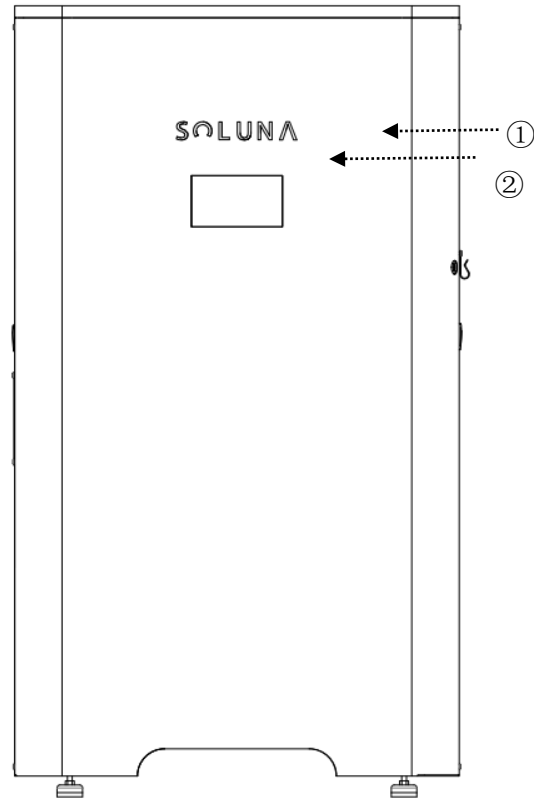

Figure 2.3 Appearance

Number	Name	Remark
①	Soluna brand	
②	LCD panel	

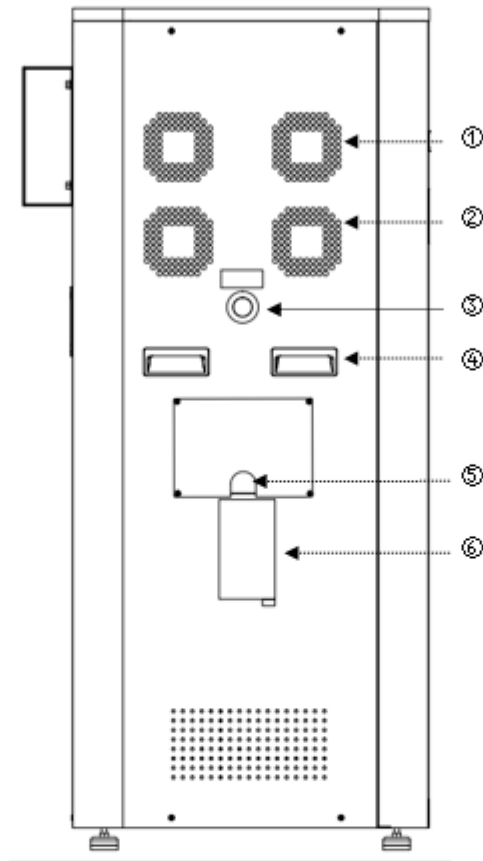

Figure 2.4 Appearance

Number	Name	Remark
①	FAN outlet	
②	FAN outlet	
③	Emergency Stop	
④	Handle	
⑤	Incoming wire port	
⑥	Label	

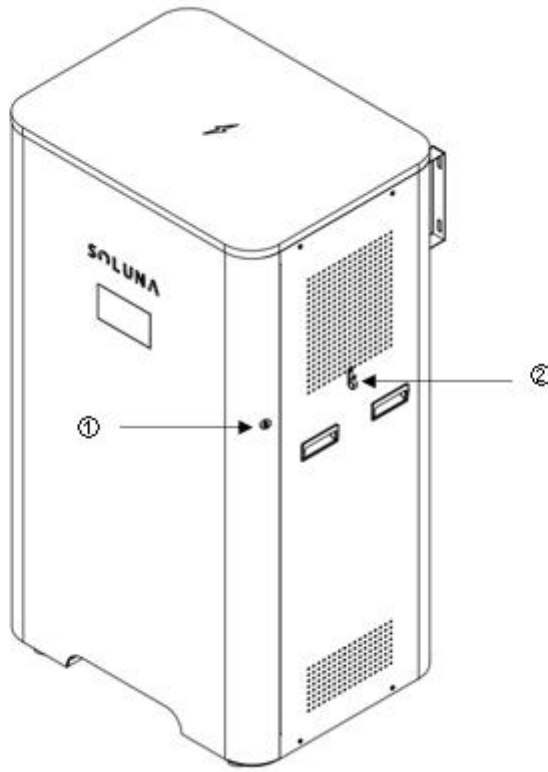



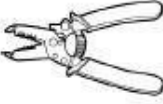
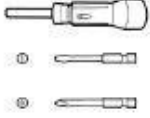













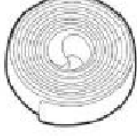





Figure 2.5 Appearance

Number	Name	Remark
①	The door lock of the system	
②	The door key	

Installation

Installation tools

Species	Tools and instruments		
Installation	 Impact drill (bit Φ 10mm)	 Torque socket wrench (sleeve opening: 13mm, suitable for M8 bolts, torque range: 0 N•m-15 N•m)	 Torque wrench (opening size: 13mm, 33mm, torque range: 0 N•m-15 N•m)
	 Diagonal pliers	 Wire stripper	 Torque screwdriver (cutting head: M4, M6, torque range: 0 N•m-5 N•m)
	 Rubber hammer	 Utility knife	 Wire cutters
	 Wire crimpers	 Open spanner	 Cable tie
	 Vacuum cleaner	 Multimeter (DC voltage range \geq 600VDC)	 Marking pen

Species	Tools and instruments		
	 Steel tape	 Level ruler	 Hydraulic clamp
	 Heat-shrinkable tubing	 Hot air heating gun	-
Personal protective equipment	 Safety gloves	 Safety goggles	 Dust mask
	 Safety shoes	-	-

Spacing during installation and subsequent operation

Installation

To ensure proper ventilation during installation, where possible, please reserve 200cms in all directions around the BESS.

During operation

Position	Min spacing	Remark
Side spacing	100cm	There needs to be a clearance of 100cm on either side of the Soluna BESS
Back spacing	10cm	It needs to be installed against the wall

Note:

For detailed requirements about the narrowest maintenance channel, escape route, etc. refer to the applicable standards of the country/region where the project is located.

Wiring specifications

To standardize the specification of AC and DC connectors or terminals of compatible inverters, the following requirements are required for connecting AC and DC wires of corresponding types of inverters

PV side	GRID side	Load
4 mm ² wire is recommended	6 mm ² wire is recommended	6 mm ² wire is recommended

Installation step

Unpacking confirmation

Before unpacking, check carefully whether the product information in the order is consistent with that on the nameplate of the package box, and whether the product package is intact. If there is any question, please contact the supplier timely. Store the idled system in its original packaging, and take anti-moisture and anti-dust measures. After removing the system from the box, check the following items:

Item	Name	Qty	Remark
1	System case	1	
2	Battery module	2	
3	key	1	
4	PV connector	2	
5	PV connector removal tool	1	
6	Screws-M6*12	14	
7	Screws-M5*8	1	
8	Screws-M4*6	6	
9	Wrench 3#	1	
10	Expansion bolts-M8*100	4	
11	Module mounting bracket	2	
12	Wall mounting bracket	2	
13	CAN1 communication line	1	
14	CAN2 communication lie	1	
15	Installation manual	1	
16	RJ45 terminal	2	
17	Current sensor	1	

Basic installation requirement

The BESS cabinet is IP20 and suitable for installation in dry, dusty environments. According to EMC standards, the BESS cabinet is designed to meet the installation requirements in a home environment. Select the installation site according to the following criteria:

- The installation site shall be well ventilated, free from rain and direct sunlight.
- The installation floor shall be dry and flat. It is strictly forbidden to have water on the ground; ensure that the ground can adequately withstand the weight of the BESS cabinet.
- The temperature in the installation environment shall range from -10 °C to 40 °C; the relative humidity can range from 5% to 95 %.
- Reserve enough installation spacing between the front, rear, left and right, top and wall of the BESS cabinet to ensure proper ventilation, heat dissipation, installation and maintenance, and safe escape.
- There are no combustible gas and flammable materials in the installation space.
- The installation environment shall be clean.

Installation procedures

The mechanical installation steps are as follows:

Step 1

Remove the S8 EU-A50 casing and the battery modules from the packaging box

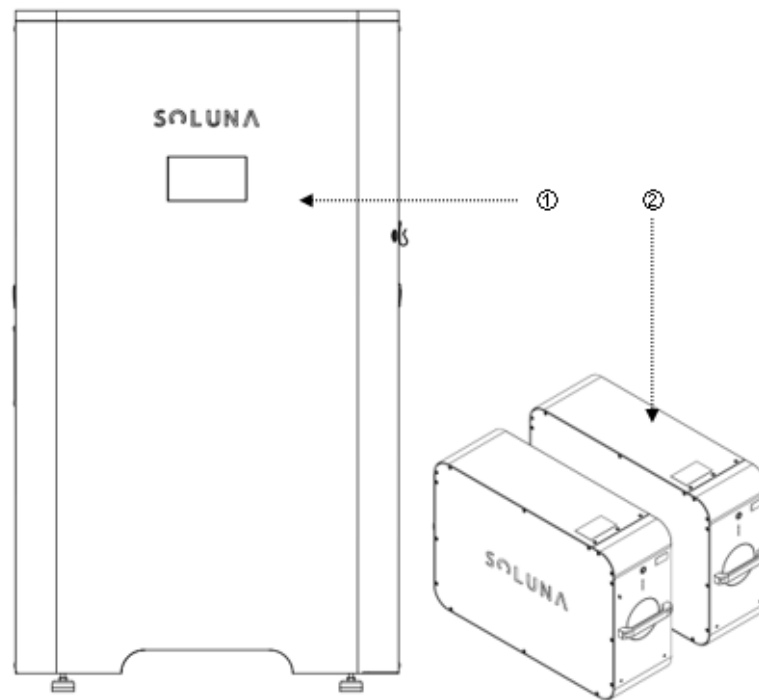

Figure 3.1 battery module & system case

Number	Name	Remark
①	System case	
②	Battery modules	

Step 2:

The casing is attached to a wall:

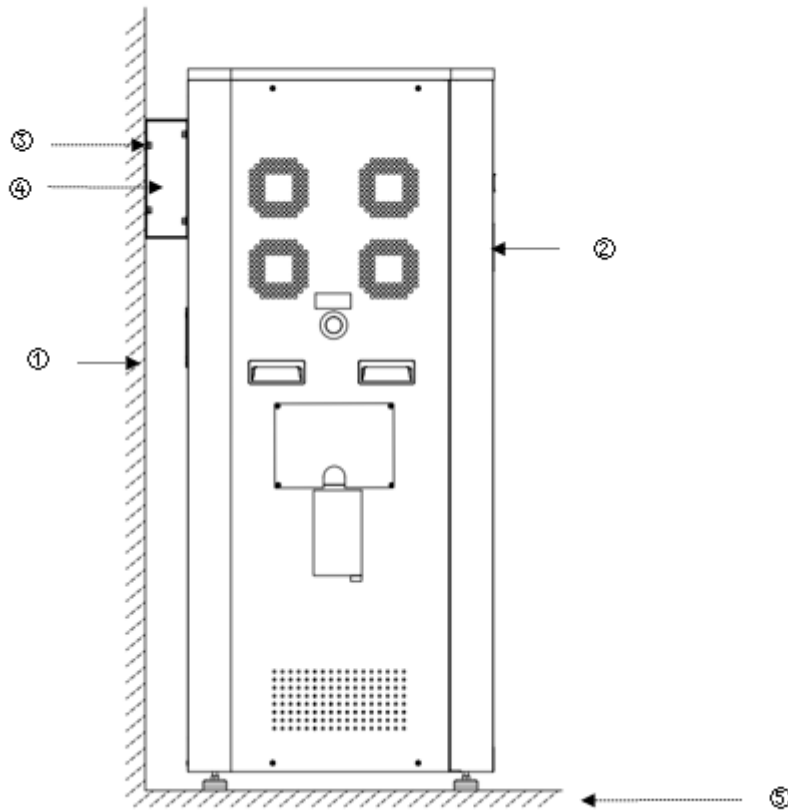

Figure 3. Attached the casing to the wall

Number	Name	Remark
①	Wall	
②	Soluna System	
③	Expansion Screw	
④	Fixed Bracket	
⑤	Ground	

Step 3

Open the door of Soluna system, and open the case of the battery module

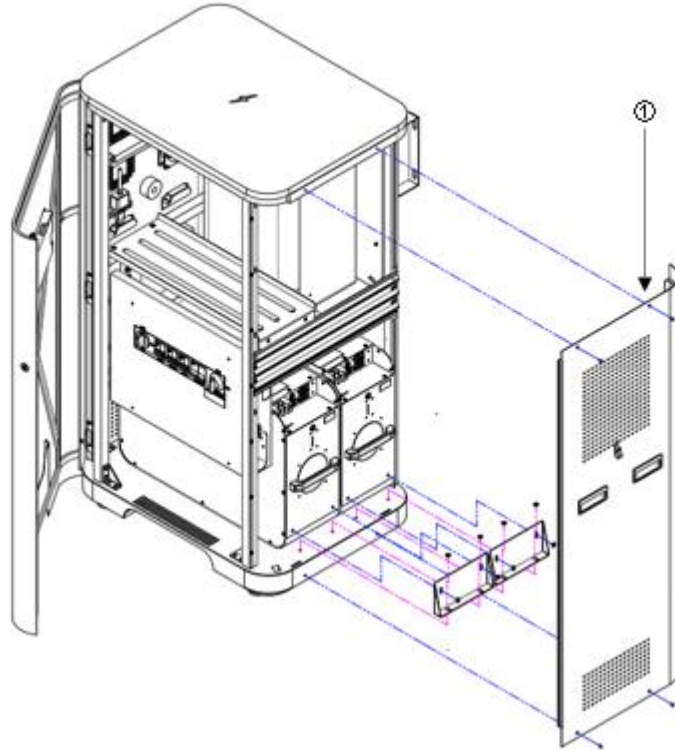

Figure 3.3 System case

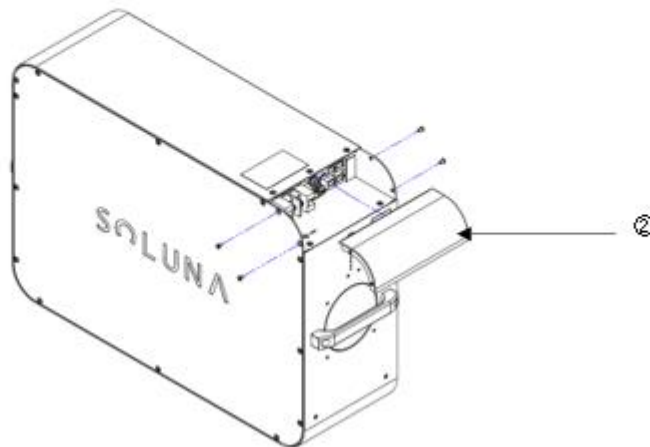

Figure 3.4 Battery Unit

Number	Name	Remark
①	System case	
②	Case of Battery module	

Step 4:

Push the battery module into the system, and lock the battery cable and plug in the CAN communication & Remote line.

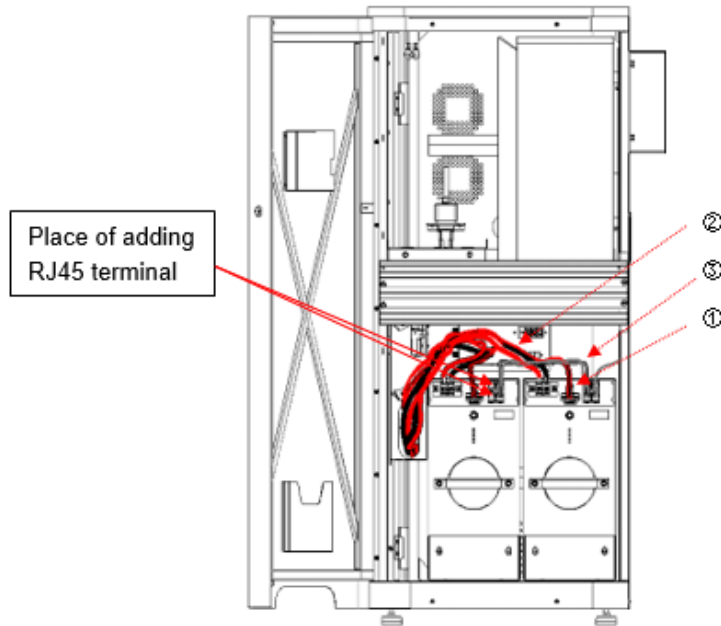

Figure 3.5 Connection for battery cable & CAN communication & Remote line

Remark: Need add RJ45 terminal on CAN1 & CAN2 BUS communication wire
In order to prevent the communication interference.
Please find the above picture for the position of adding RJ45 terminal.
User can find the RJ45 terminal in the accessories.
Please find the following picture for RJ45 terminal for details

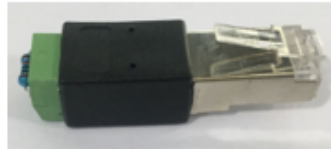

Figure 3.6 RJ45 terminal

Number	Name	Remark
①	Remote wire	
②	Battery cable	
③	CAN communication line	

Remark: Connecting wire for communication line

1. All CAN1 lines are parallel for the internal communication of battery units
2. All CAN2 lines are parallel for external communications.
(between battery unit and the hybrid inverter), then CAN2 is connected to the inverter.

Step 5

Fixed battery module and close the door of the BESS.

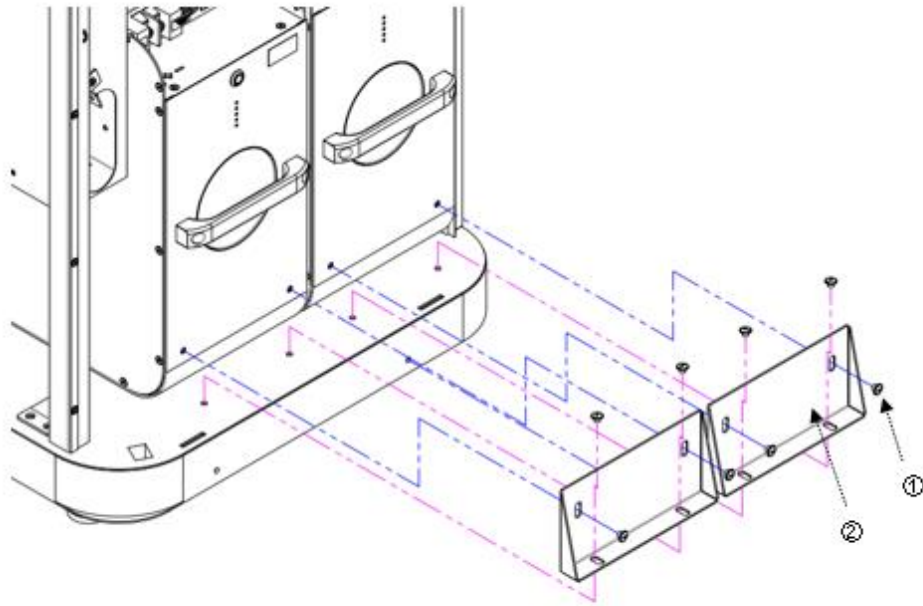

Figure 3.7 Fixed battery module

Number	Name	Remark
①	M6*12 Combination screw	
②	Fixed bracket	

Step 6

External circuit connection (PV\GRID\LOAD)

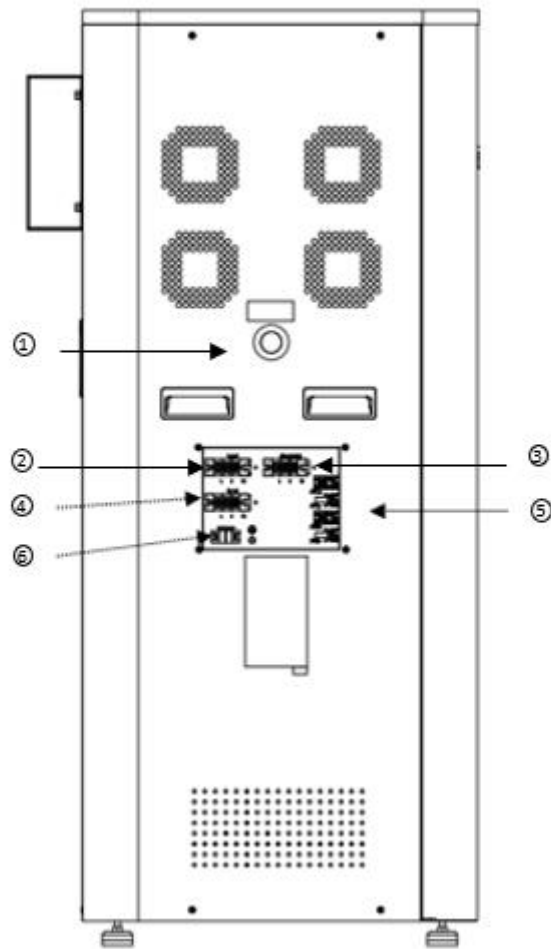

Figure 3.8 External circuit connection

Number	Name	Remark
①	Emergency Stop	
②	Load connector	
③	Grid connector	
④	GEN connector	
⑤	PV connector	
⑥	GEN control port	

PV connection



Only qualified PV strings under the local electrical safety laws and regulations and comply with the technical parameters of this manual are allowed to connect to the Soluna S8 EU-A50. The PV string connected to the BESS must adopt the DC connector configured for the BESS. Do not use other connection devices without authorization from our company; otherwise, damage to the equipment, unstable operation or fire may occur, and Soluna will not undertake quality assurance or assume any direct or joint liability thereof.

Note:

It is recommended to use 4mm wire for PV connecting wire.

PV terminal crimping - Terminal crimping torque 3.6–4.6 N.m.

- Ensure that the maximum open-circuit voltage of each PV string is not higher than the maximum input voltage of the BESS under any circumstances.
- It is forbidden to connect the PE wire (ground wire) to the positive and negative poles of the PV strings; otherwise, it will cause damage to the BESS .
- Ensure that the PV string polarity matches the PV connector; otherwise, the BESS will be damaged.
- The insulation resistance of the PV panel to the ground should be greater than the safety regulation; otherwise, there will be electrical hazards.
- Ensure the wires of the cable correspond to the connector terminals, and tighten the screws. The crimping torque of the screws is 1.5–2.5 N.m.
- Use a multimeter to measure the voltage of the DC input string, verify the polarity of the DC input cable, and ensure that the voltage of each string is within the allowable range of the system.



Grid & Load connection



Only qualified AC transmission cables under the local electrical safety laws and regulations and comply with the technical parameters of this manual are allowed to connect to the Soluna S8 EU-A50

Recommended wire specifications for safe system operation are as shown in the following table.

GRID side	LOAD side
6 mm ² wire is recommended	6 mm ² wire is recommended

Terminal crimping of wires L, N, and PE of the mains and load cables Terminal crimping torque 3.6–4.6 N.m.

Note:

- Before connecting the AC power Grid cable to the BESS, the lightning protection and short circuit protection measures must be taken following the local electrical safety regulations. The PE cable (grounding cable) of the system must be reliably grounded.
- Connect the three wires L, N, and PE of the single-phase public power Grid to the corresponding AC terminals, fasten them, and tighten the screws. The crimping torque is 1.5–2.5 N.m.
- Connect the three wires L, N, and PE of the load to the corresponding load terminals, fasten them, and tighten the screws. The crimping torque is 1.5–2.5 N.m.

Step 7 :

Electrical connection

- A. The following diagram is an example for the Australia, South Africa and New Zealand grid systems. Please see Figure A for details.

Note:

In Australia, the neutral cable of the On-Grid side and Back-Up side must be be connected together, otherwise Back-Up function will not work.

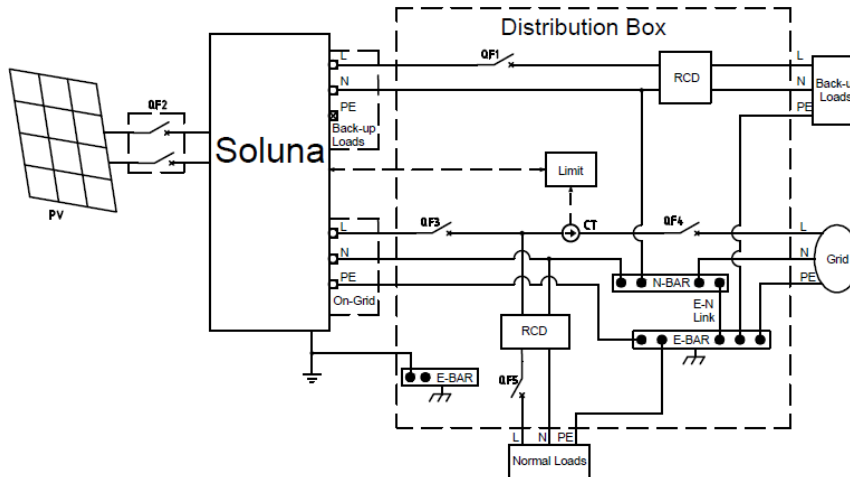

Figure A

- B. The following diagram is an example for grid systems without special requirement On electrical wiring connection.

Note:

The back-up PE line and rack earth must be grounded properly and effectively; otherwise, the back-up function may be abnormal when the grid fails.

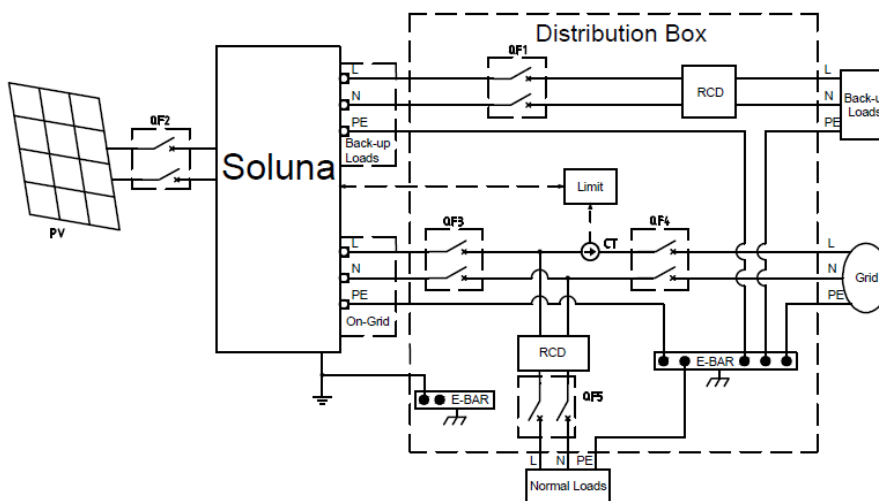

Figure B

C. The following diagram is an example for off-grid system

Note:

After the inverter is installed and working as a Grid-connected BESS, please turn off the grid power to check if the back-up function is working to avoid potential problems for subsequent uses.

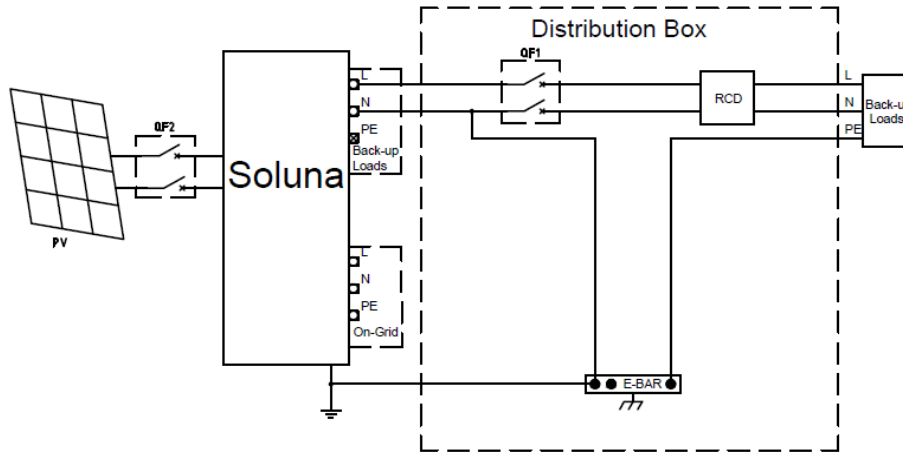

Figure C

Remark:

Although the RCD is shown the Soluna system itself has the function of leakage protection, therefore the RCD is a suggestion, not a requirement, the RCD provides an extra layer of protection. If installing an RCD, we recommend an RCD with a 32A rating and a type AC

How to operate Soluna S8 EU-A50

Turn on or turn off the Soluna S8 EU system

Turn on: Open the door, and turn on all the switch of Load/Grid/Battery/Remote.

Turn off: Open the door, and turn off all the switch of Load/Grid/Battery/Remote.

Please see the image of the switches below.

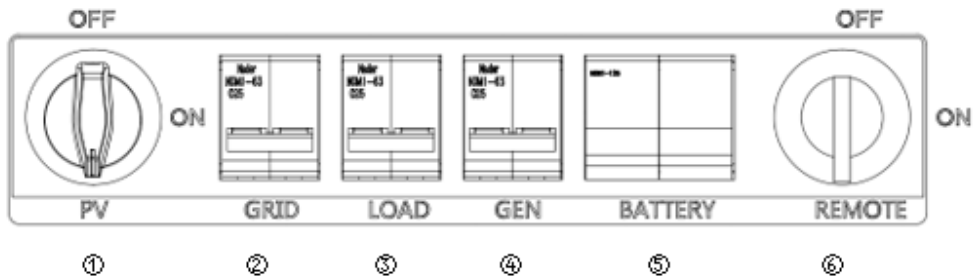

Figure 3.9 Turn on\Turn off system

Number	Name	Remark
①	PV Switch	
②	Grid breaker	
③	Load breaker	
④	GEN breaker	
⑤	Battery breaker	
⑥	Remote switch	

How to operate the LCD

The LCD can be found on the front of the system (see image below).

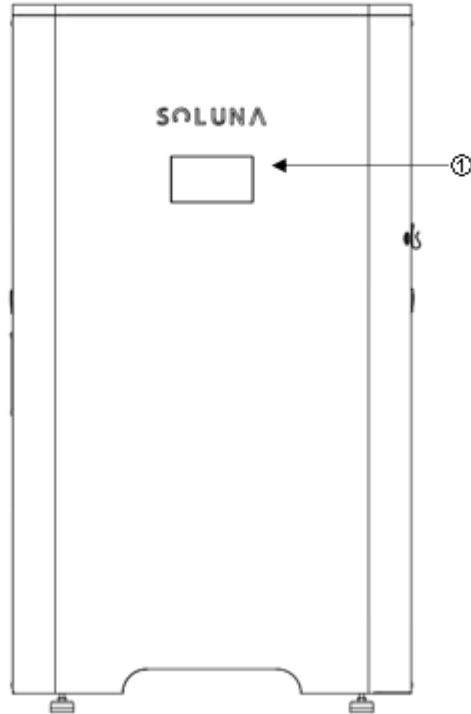

Figure 4.0 LCD

Number	Name	Remark
①	LCD panel	

Note:

The LCD is operated by touch, to view the information in the LCD simply touch to view the details.

How to check the information on the LCD screen

The LCD screen includes 5 icons:

1. Status
2. Settings
3. Data
4. Production information
5. Battery capacity (in the middle)

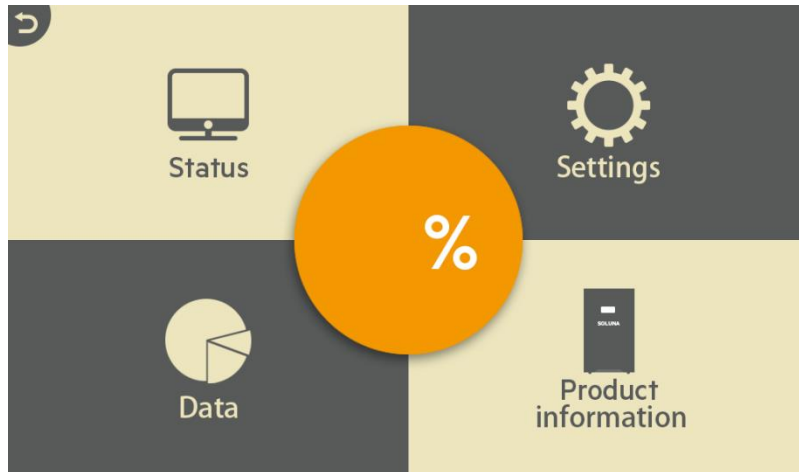

Figure 4.1 LCD Screen

How to check the information of the PV/Load Power/Feed-in power/Battery power.

The user can see the below interfaces after clicking the icon of status



Figure 4.2 information of status icon

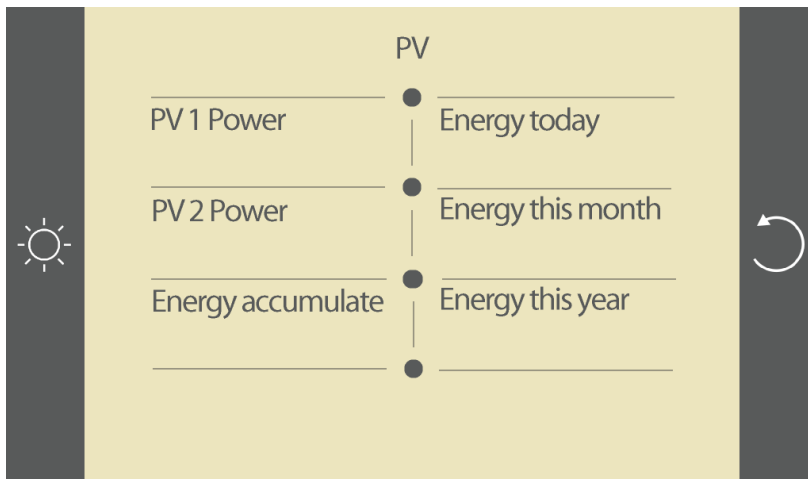

Figure 4.3 PV information

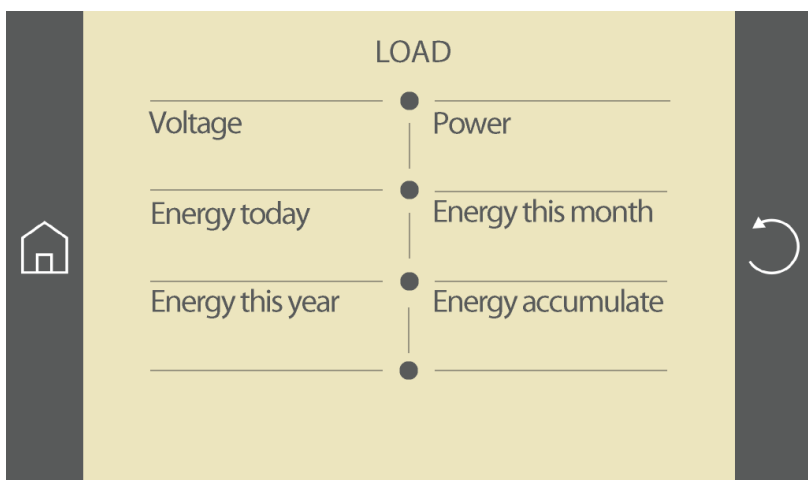

Figure 4.4 Load information

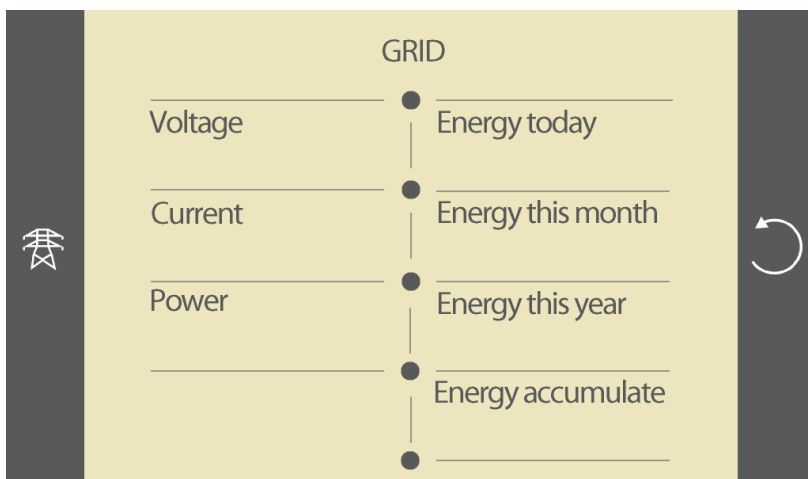

Figure 4.5 Grid information

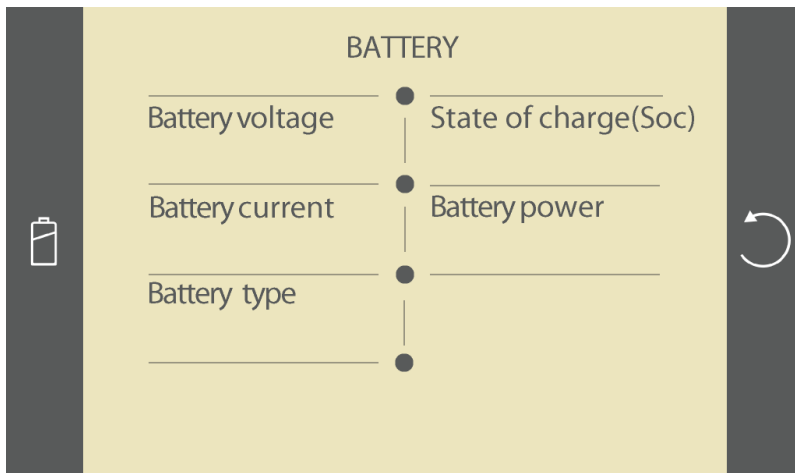

Figure 4.6 Battery information

How to Setting parameters of Soluna system

The user will find the following interface after clicking the icon of “Setting”.

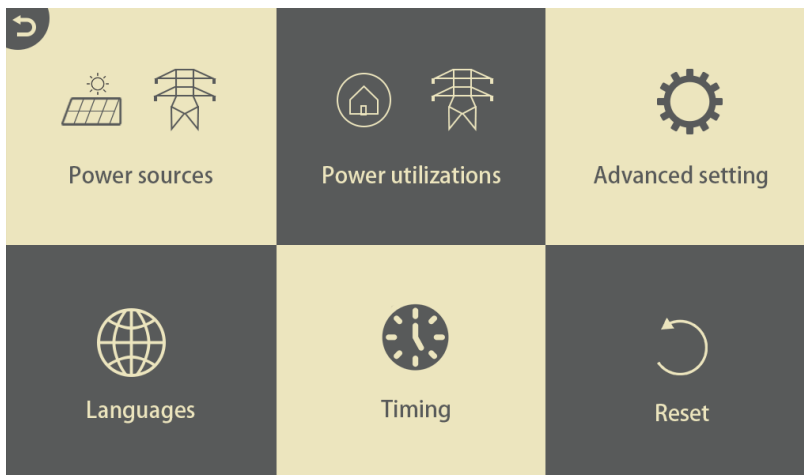

Figure 4.7 Setting icon information

The user can find the following interface after clicking the icon of Power sources.

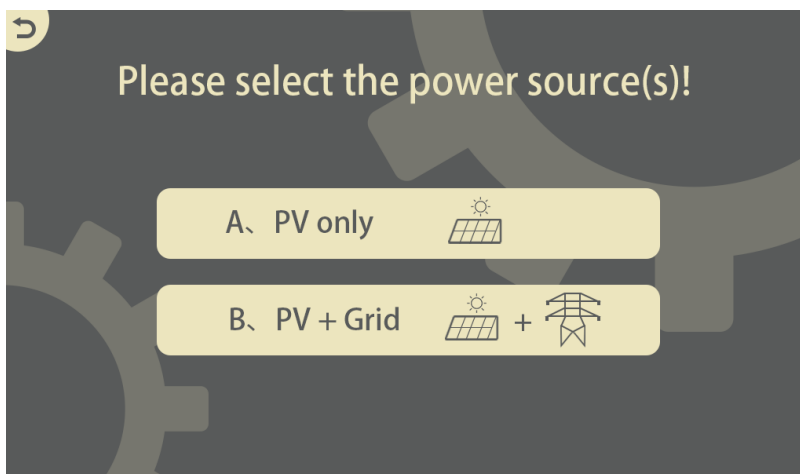

Figure 4.8 Power source

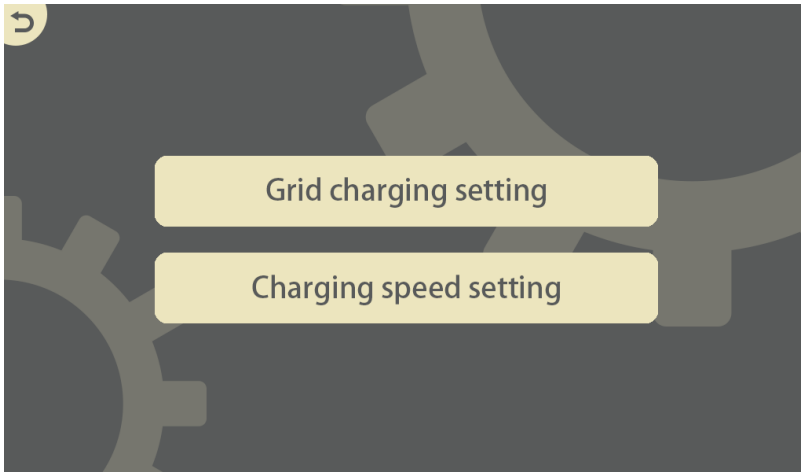

Figure 4.9 Charging setting (1)

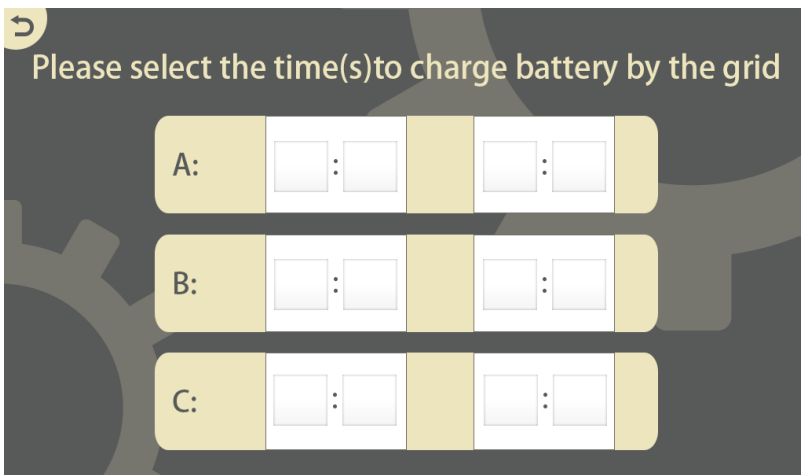

Figure 4.10 Charging setting (2)

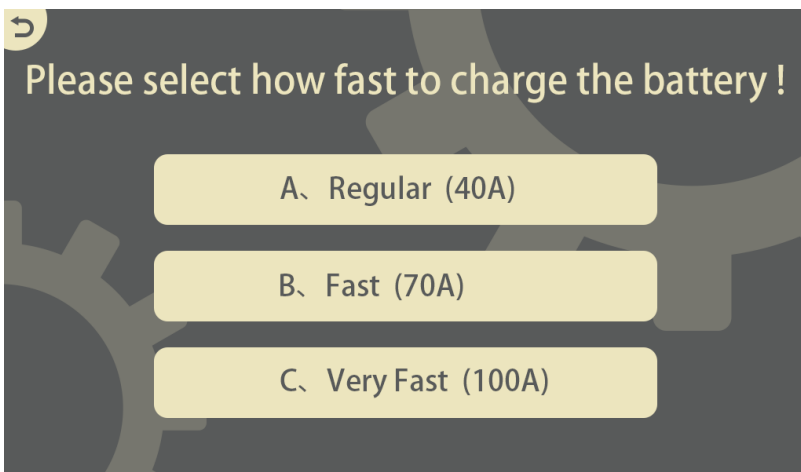

Figure 4.11 Charging setting (3)

The user can find the following interface after clicking the icon of power utilizations

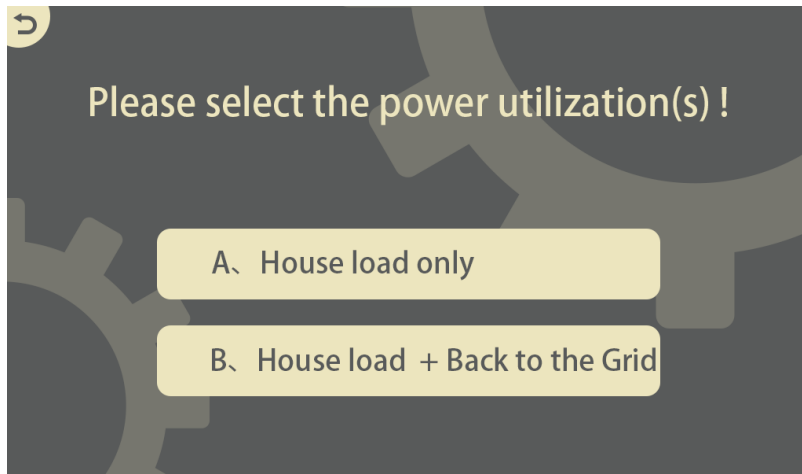

Figure 4.12 Discharging setting (1)

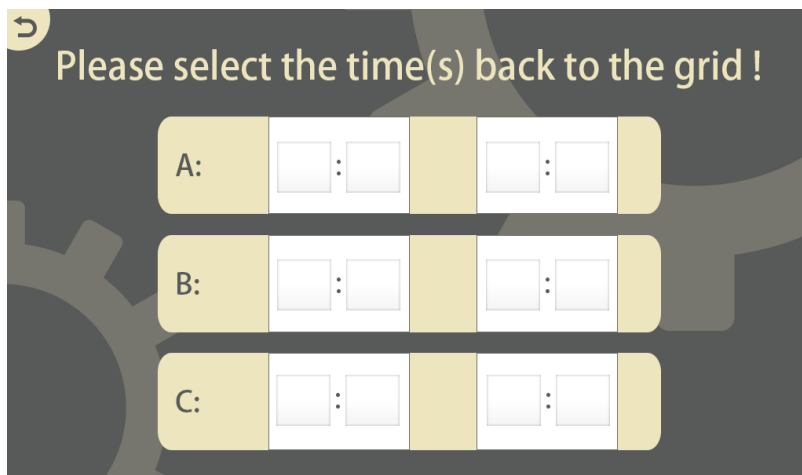

Figure 4.13 Discharging setting (2)

The user can find the following interface after clicking the icon of Languages

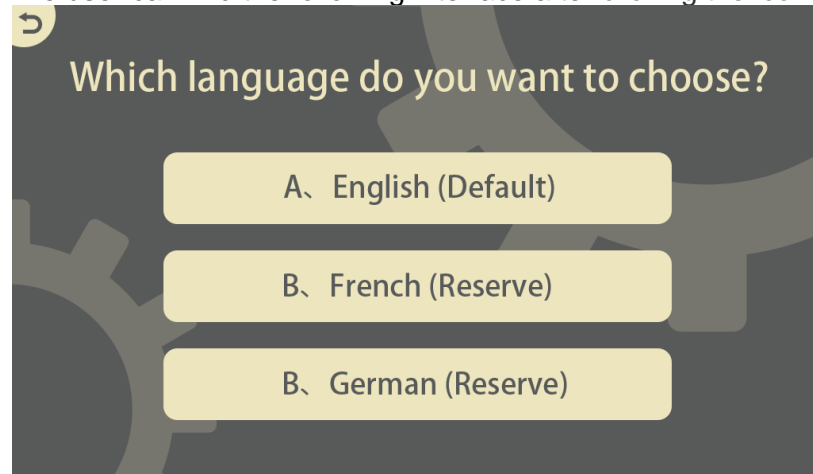

Figure 4.14 Language selection

Remark: There are 3 kinds of language option in the Soluna system English the default, French and German are also available.

The user can find the following interface after clicking the icon of timing

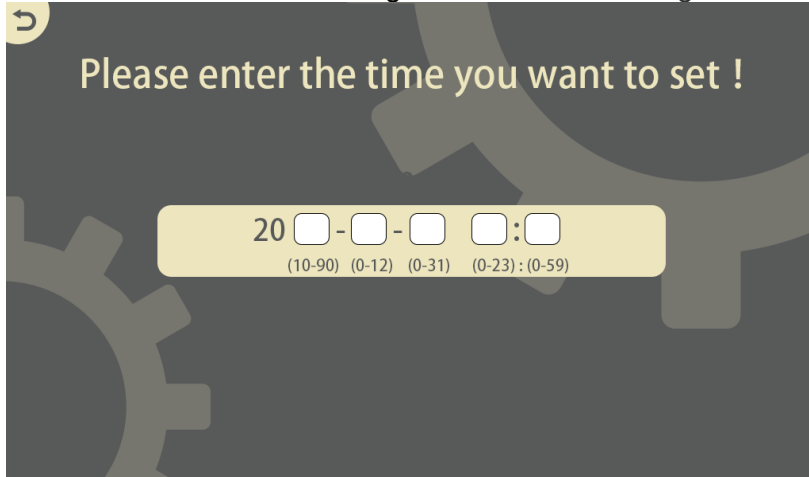

Figure 4.15 Timing setting

The user can find the following interface after clicking the icon of reset & advanced settings. The user needs to enter password if the user wants to restore the parameters of the S8 EU-A50. (Soluna can provide the password if required)

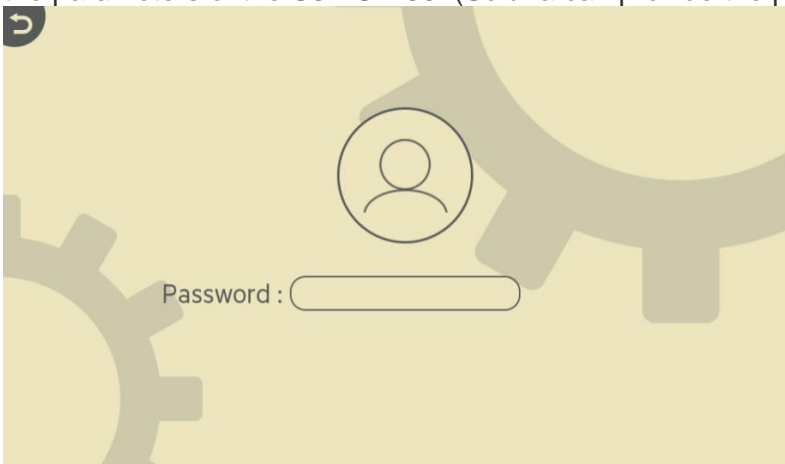

Figure 4.16 Password enter

The user needs to confirm again it after setting the parameters of Soluna system.

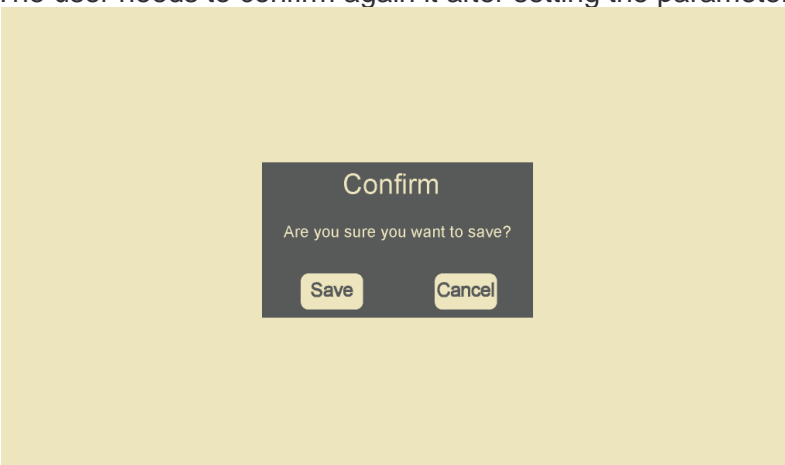

Figure 4.17 Confirm

How to check the information of “Data” icon.

The user can find the following interface after clicking the icon of Data



Figure 4.18 Data icon

The user can find the following interface after clicking the icon of Solar generation

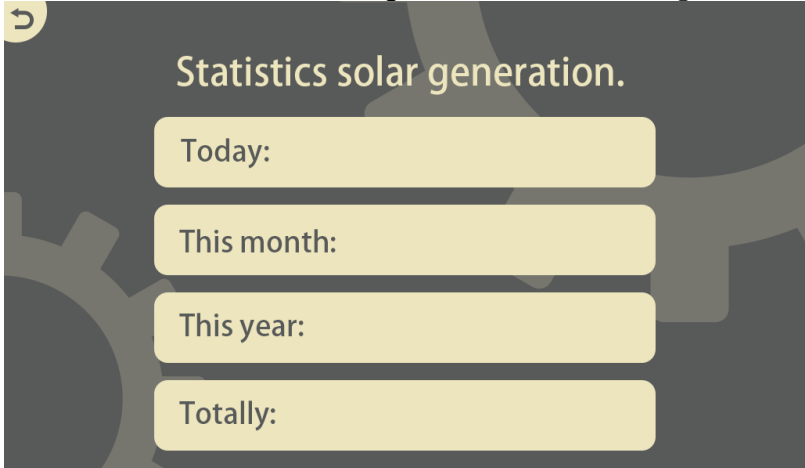

Figure 4.19 Statistics solar generation

The user can find the following interface after clicking the icon of “back to grid”

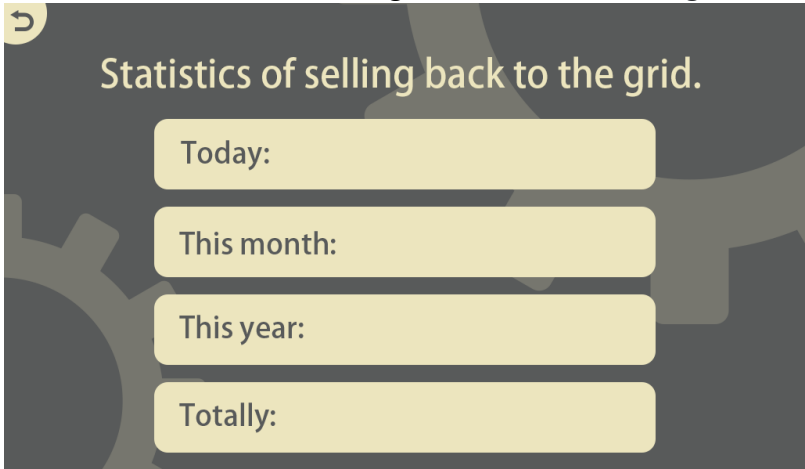

Figure 4.20 Statistics of selling back to the grid

User can see the following interface after clicking the icon of “Equivalent tree planting”.

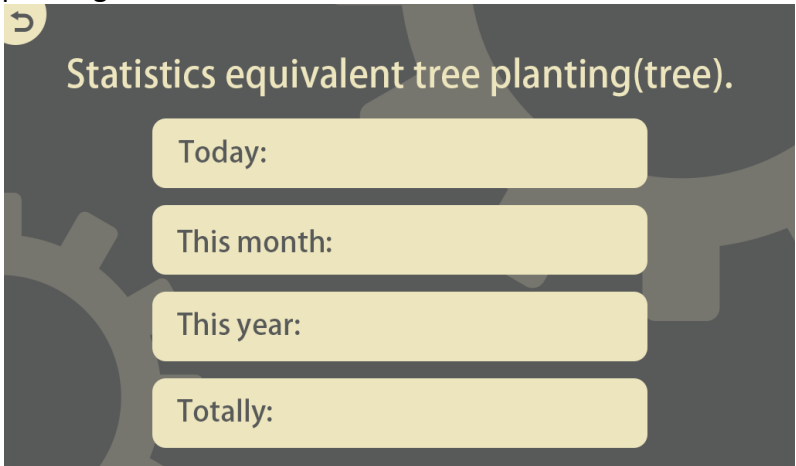

Figure 4.21 Equivalent tree planting

The user can find the following interface after clicking the icon of “save the earth”.

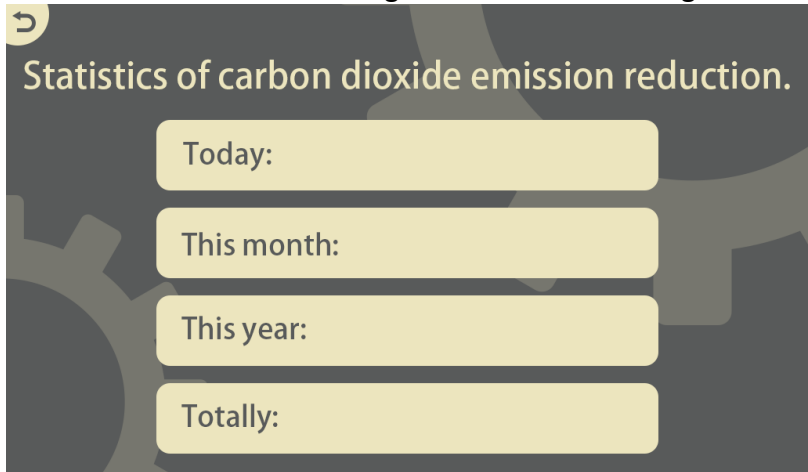

Figure 4.22 Carbon dioxide emission reduction

How to check the production information of Soluna system

User can find the fault information after clicking the icon of “production information”.

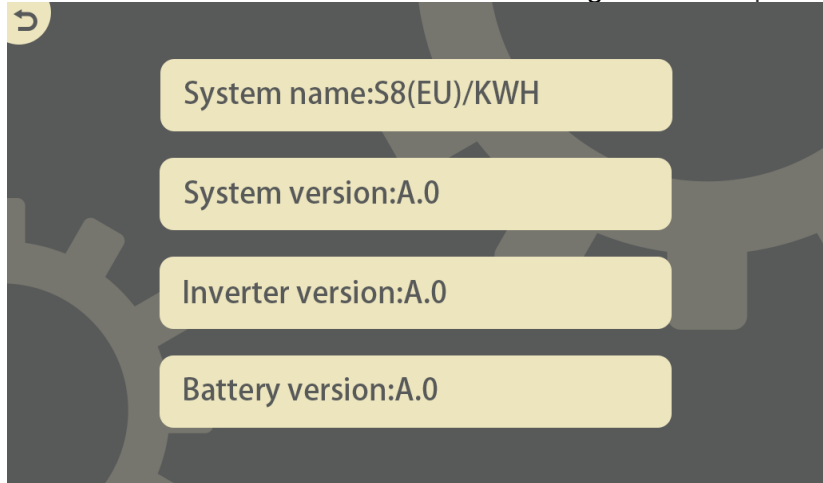

Figure 4.25 Production information

How to Check the fault information

The user can find the fault information after click the fault icon

Remark: The user will find an icon blinking in the upper right corner of the LCD panel if there is any fault during Soluna system operation

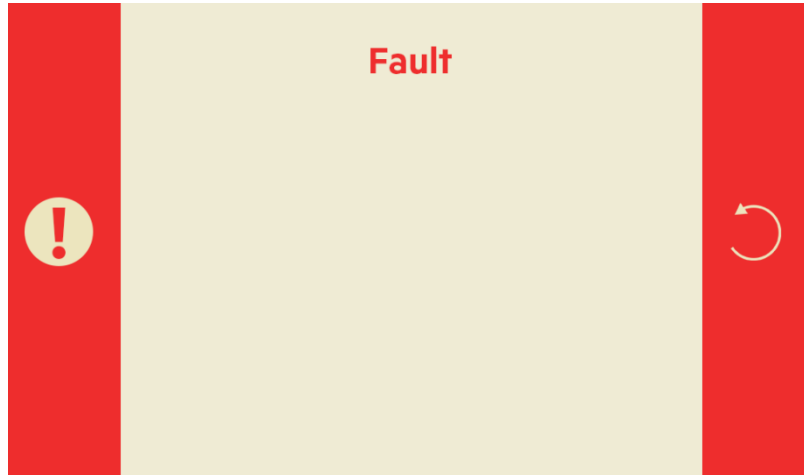

Figure 4.26 Fault information

How to maintain

Fan maintenance

The expected life of the BESS fan' is 70000 hours under continuous working. The higher the ambient temperature, the shorter life of service of the fan. Check the fan every year to see the fan is working correctly; make sure there is air blowing out from the outlet of the system.

Note: Shut down the fan before maintenance, to avoid personal injury and device damage caused by electric shock and fan blades rotation at high speed.

Clearance

Regularly clean the whole system, especially the ventilation holes to ensure the free flow of air to the housing. If necessary, use a vacuum cleaner to clear the dust and any other particles hindering the ventilation of the system.

Note: Shut down the fan before cleaning, to avoid personal injury and device damage caused by electric shock and fan blades rotation at high speed.

Fault handling

If the Soluna system has any failure information shown in the table below, and it has not been eliminated after a restart, please contact your local distributor or Soluna.

Item	Description	Remark
1	Ac voltage high1	
2	Ac voltage high2	
3	Ac voltage low1	
4	Ac voltage low2	
5	Ac freq. high1	
6	Ac freq. high2	
7	Ac freq. low1	
8	Ac freq. low2	
9	Ac over currhw	
10	Ac over currsw	
11	Bus overvolt hw	
12	Bus overvolt sw	
13	Gfci over	
14	Gfci sensor fault	
15	Relay fault	
16	Iso low	
17	Ac DC over	
18	DSP communication error	
19	PV soft fault	
20	Ac zero error	
21	Temperature high1	

22	LLC soft fault	
23	LLC overvoltage	
24	LLC over current	
25	PV1 voltage high	
26	PV1 voltage low	
27	PV2 voltage high	
28	PV2 voltage low	
29	PV1 over current	
30	PV2 over current	
Item	Description	Remark
31	RTC error	
32	Eeprom error	
33	Inv soft fault	
34	Fan fault	
35	Cmd shut down	
36	Grid loss	
37	Load over current	
38	Battery over current	
39	Battery volt high	
40	Battery open	
41	Quick stop	
42	Pv1 over current hw	
43	Pv2 over current hw	
44	Bat over current hw	
45	LLC over current hw	
46	LLC over-voltage hw	
47	CAN comm error	
48	Load overpower	
49	Extern Battery Alarm	
50	Load error hw	
51	Battery volt low	
52	PE Fault	
53	DRM0Fault	
54	Dis/Chrg time conflict	
55	Grid Abnormity	

How to use the generator & AC couple function

The S8 EU-A50 BESS can function with diesel generator & AC couple. If the user wants to use the diesel generator & AC function, please contact to us, following the engineers' instruction to operate.

Remote monitoring

1. Download APP

iPhone: Search "Soluna" in Apple Store.

Android: Search "Soluna" in Google play Store.

Remark: Please see below picture for Soluna Icon



2. Register

Click [Register] to create new account. you can use email to register.

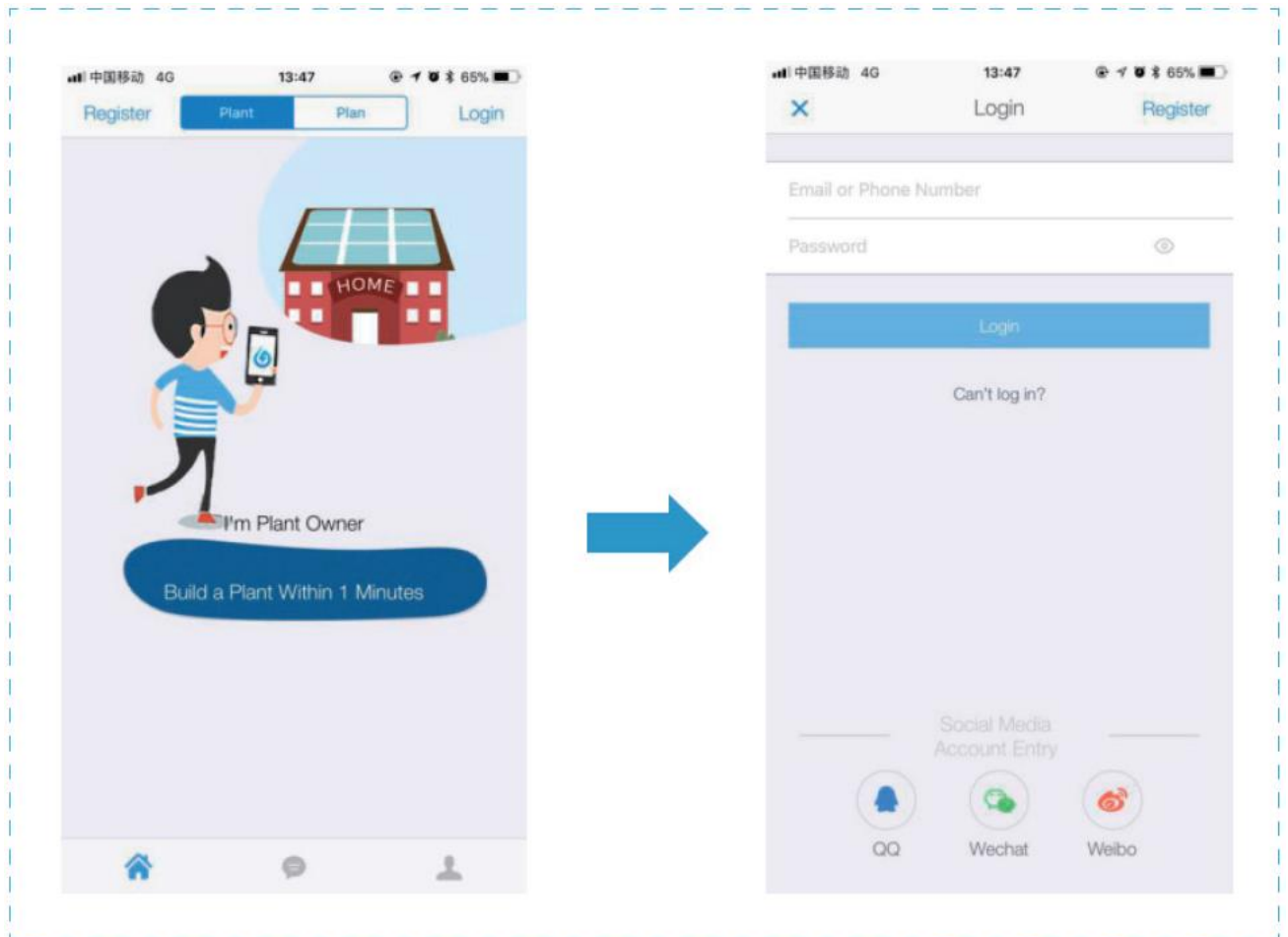

3. Create Plant

3.1 Click [+] and select [Create Plant]. Then scan the serial number of the stick logger, or manually enter the serial number.

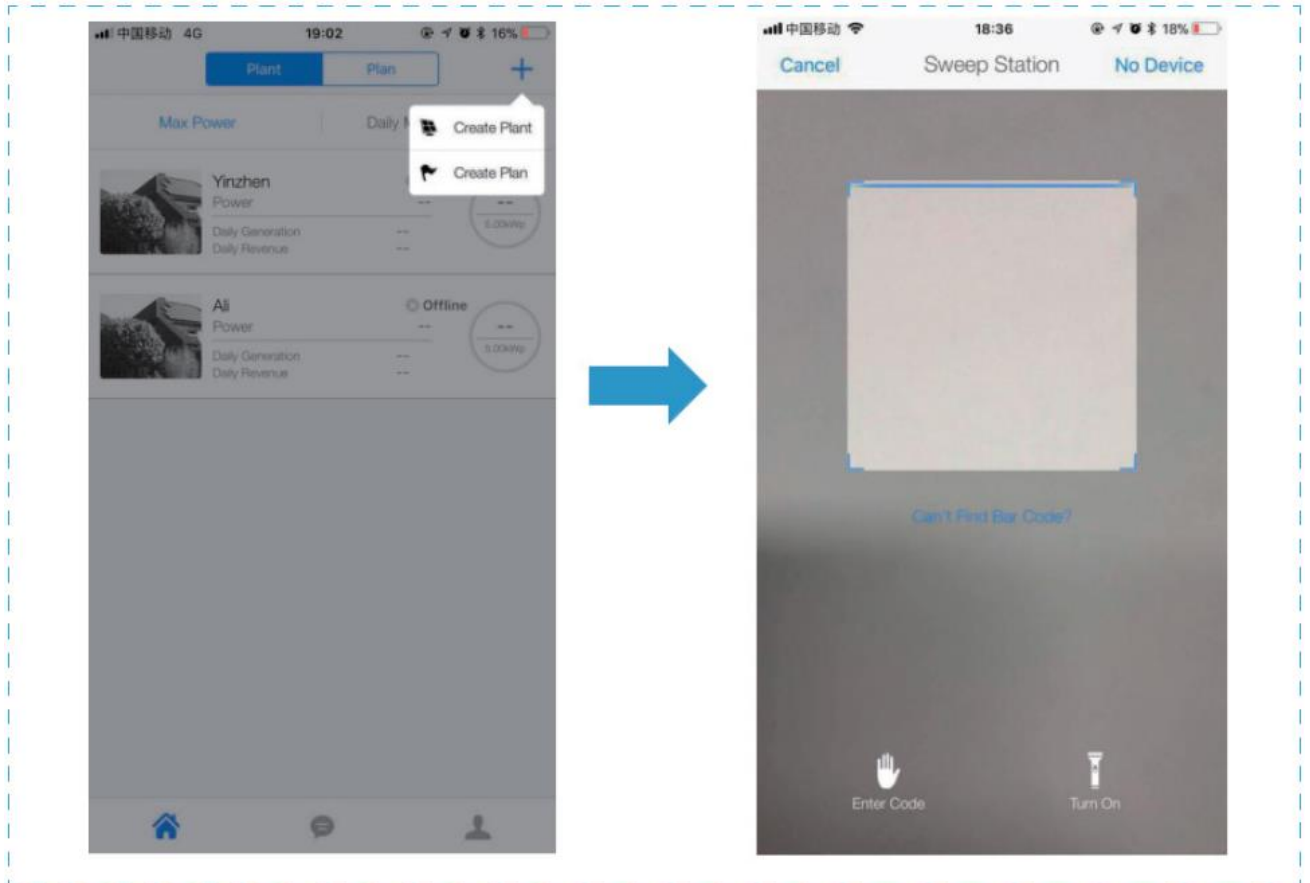

3.2 Edit plant information.

- 1) Confirm your plant location (GPS function will automatically determine the plant site, if you want to modify the location, click the "map" icon, and then manually enter the address in box b)
- 2) Select your plant type
- 3) Select your grid type
- 4) Fill in plant capacity

(You may keep the default settings in the rest of blank because APP has received local electricity prices and subsidies)

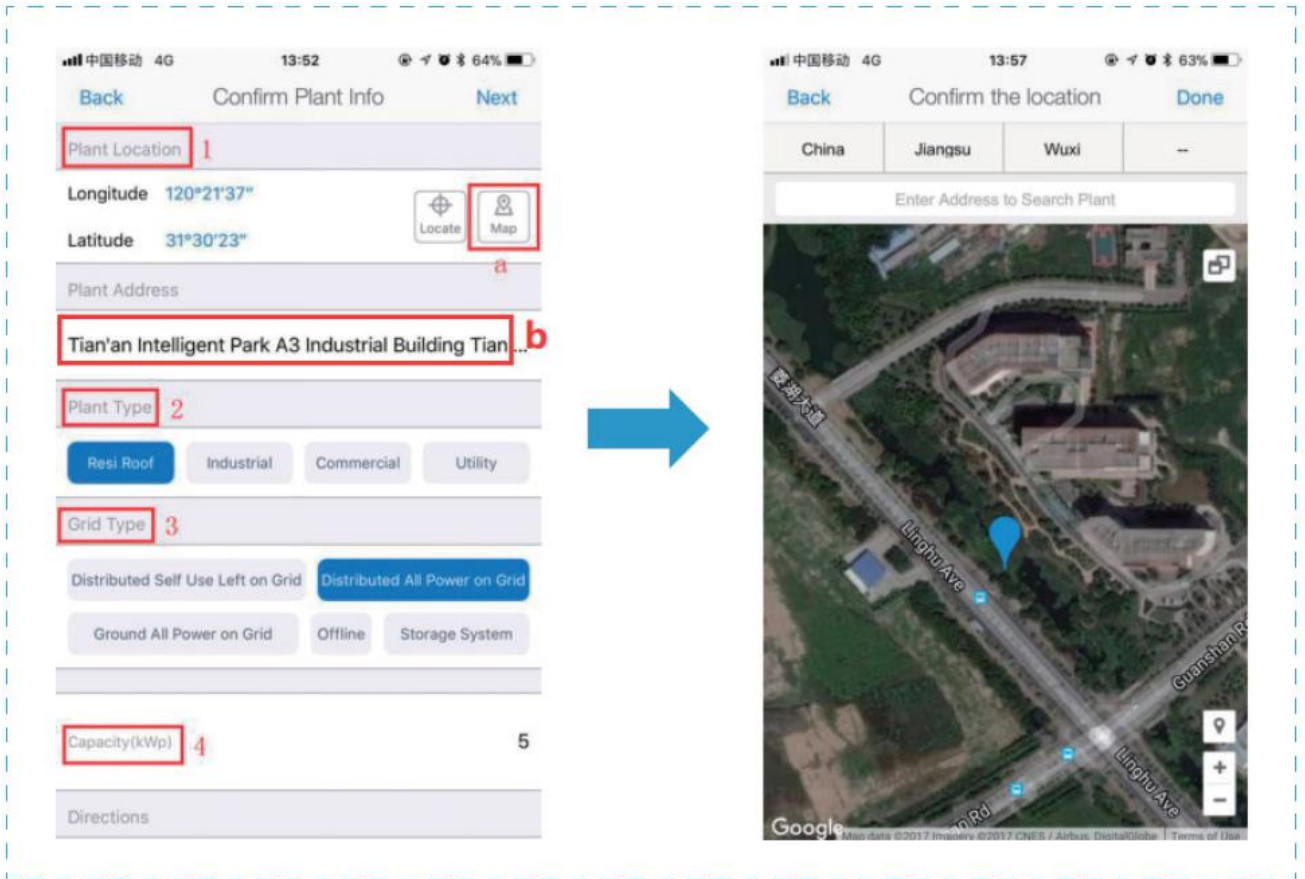

3.3 Input Plant Name

It is suggested to create a plant name like "location+name+capacity" (e.g. Soluna 8.1KW), then click [Done].

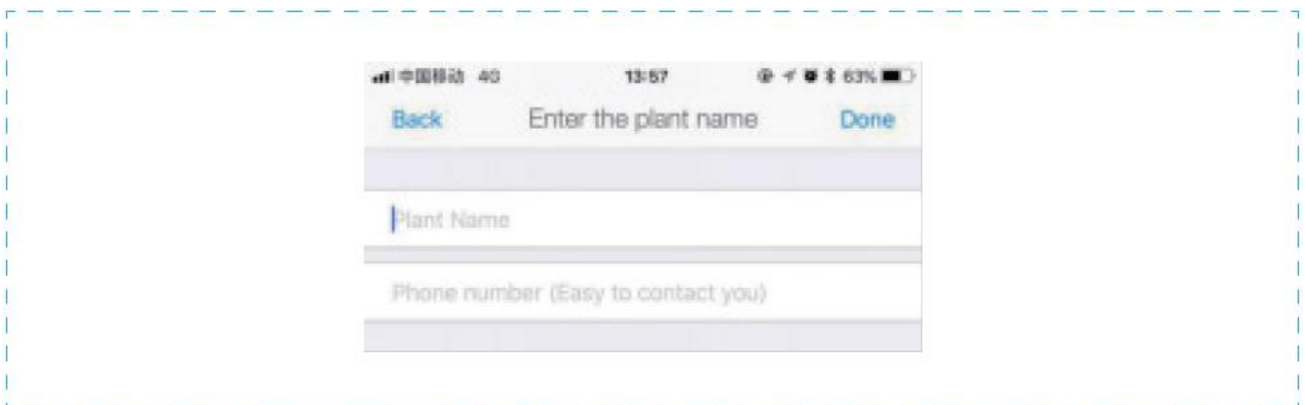

3.4 Now you can see your plant on the homepage

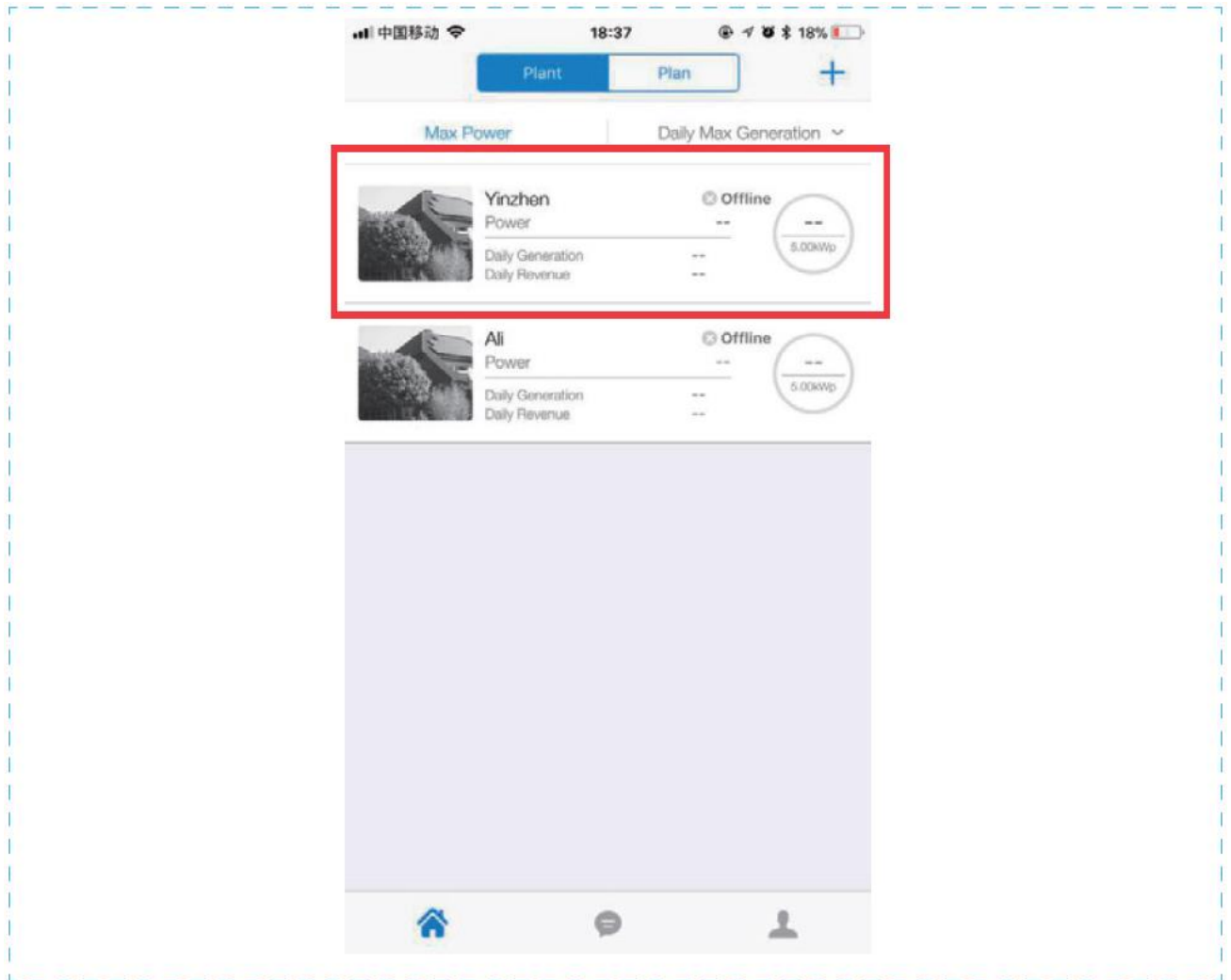

4. Wi-Fi Connection Configuration

Select the plant and click [Connect Again] in the tab [Device], select your device and click [Done] to the next step.

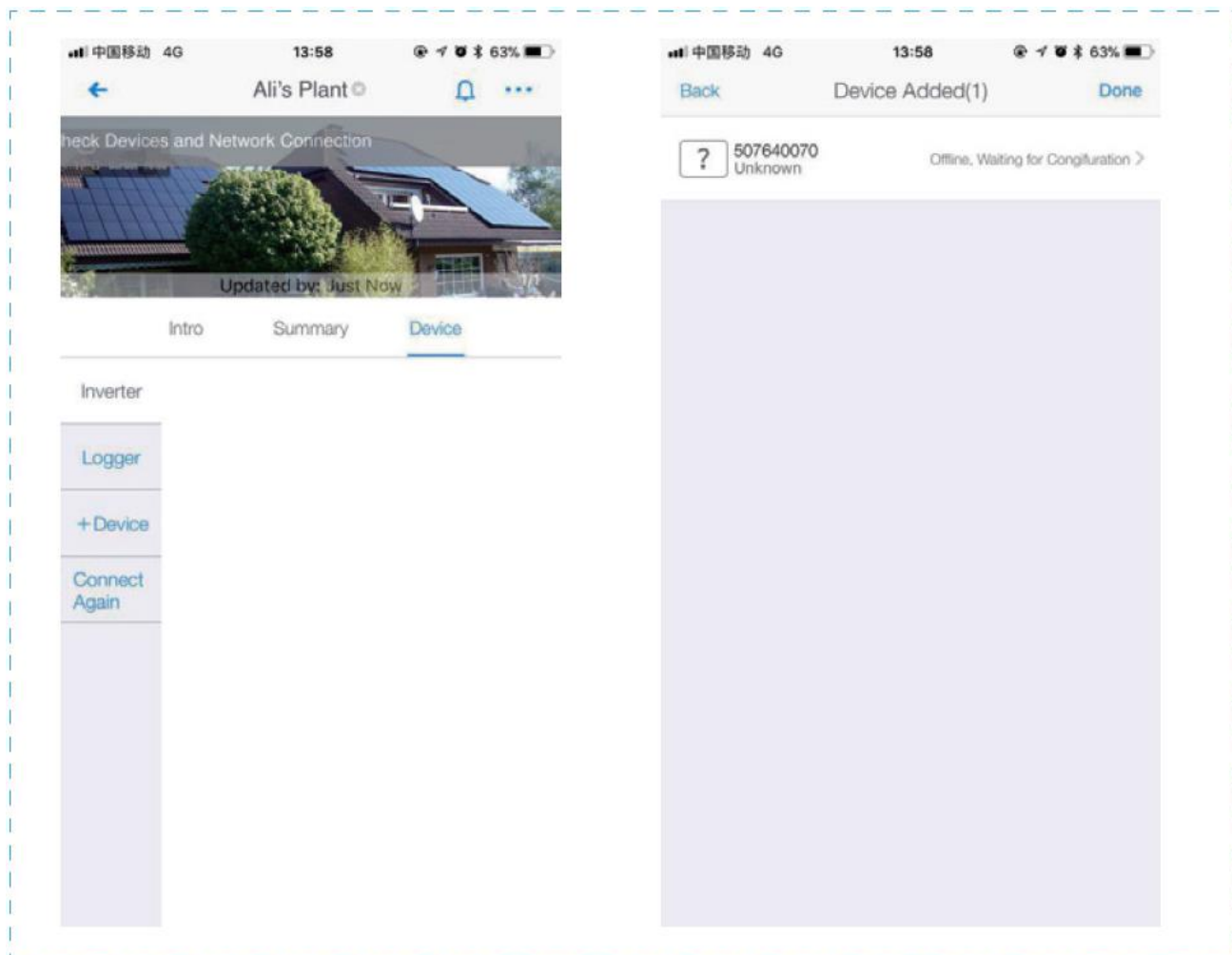

Configuration (for Android user)

- 1) APP will automatically get your Wi-Fi network, so you need to enter your Wi-Fi password to continue the configuration, if the network is not accurate, select [switch network], then find or manually enter the network ID.

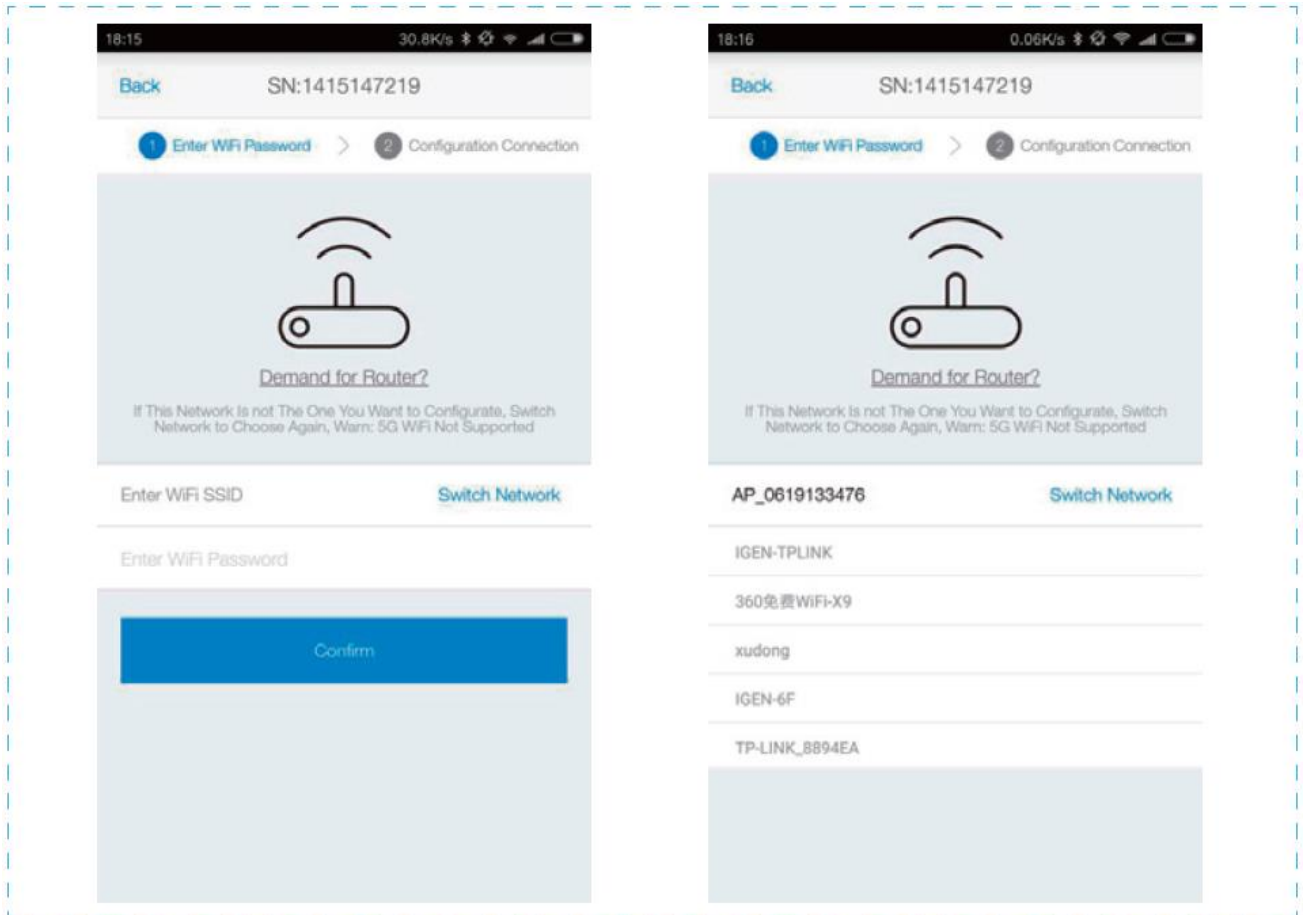

2) The connection will automatically start after connect the network

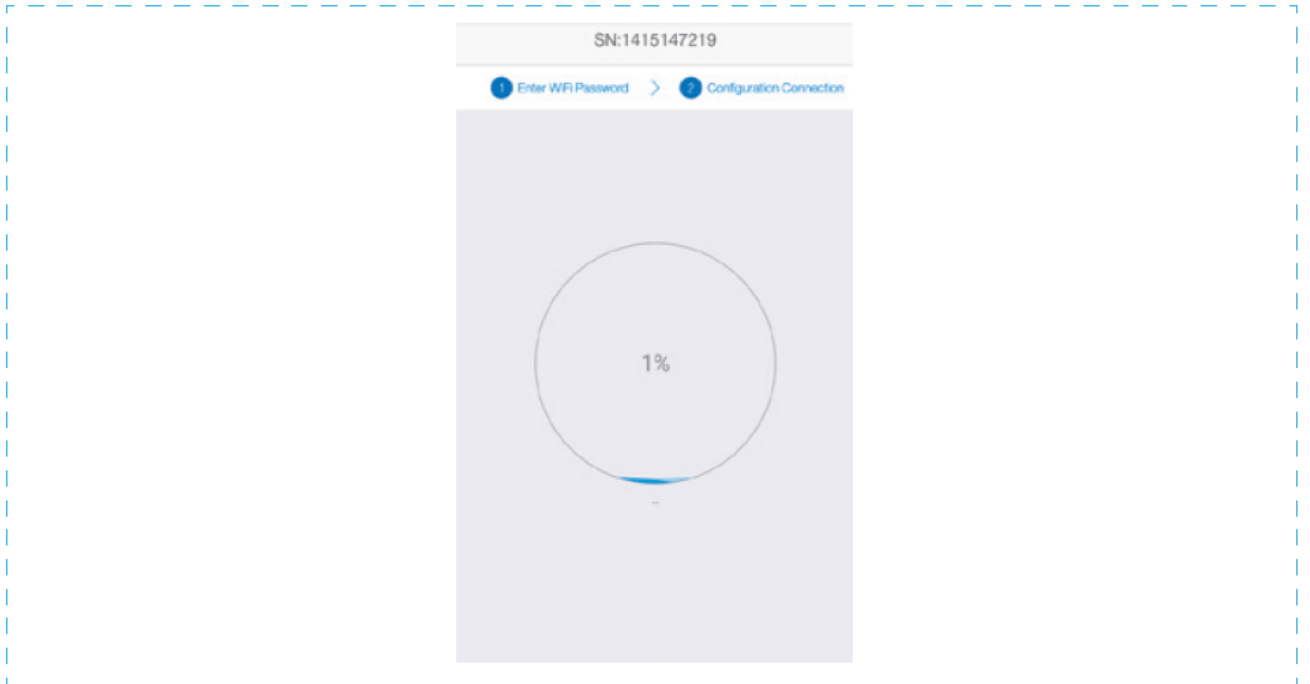

3) It normally takes 3~5 minutes to configure successfully. Then, you can go back to tab [Device] and click [+Device] to add more devices.

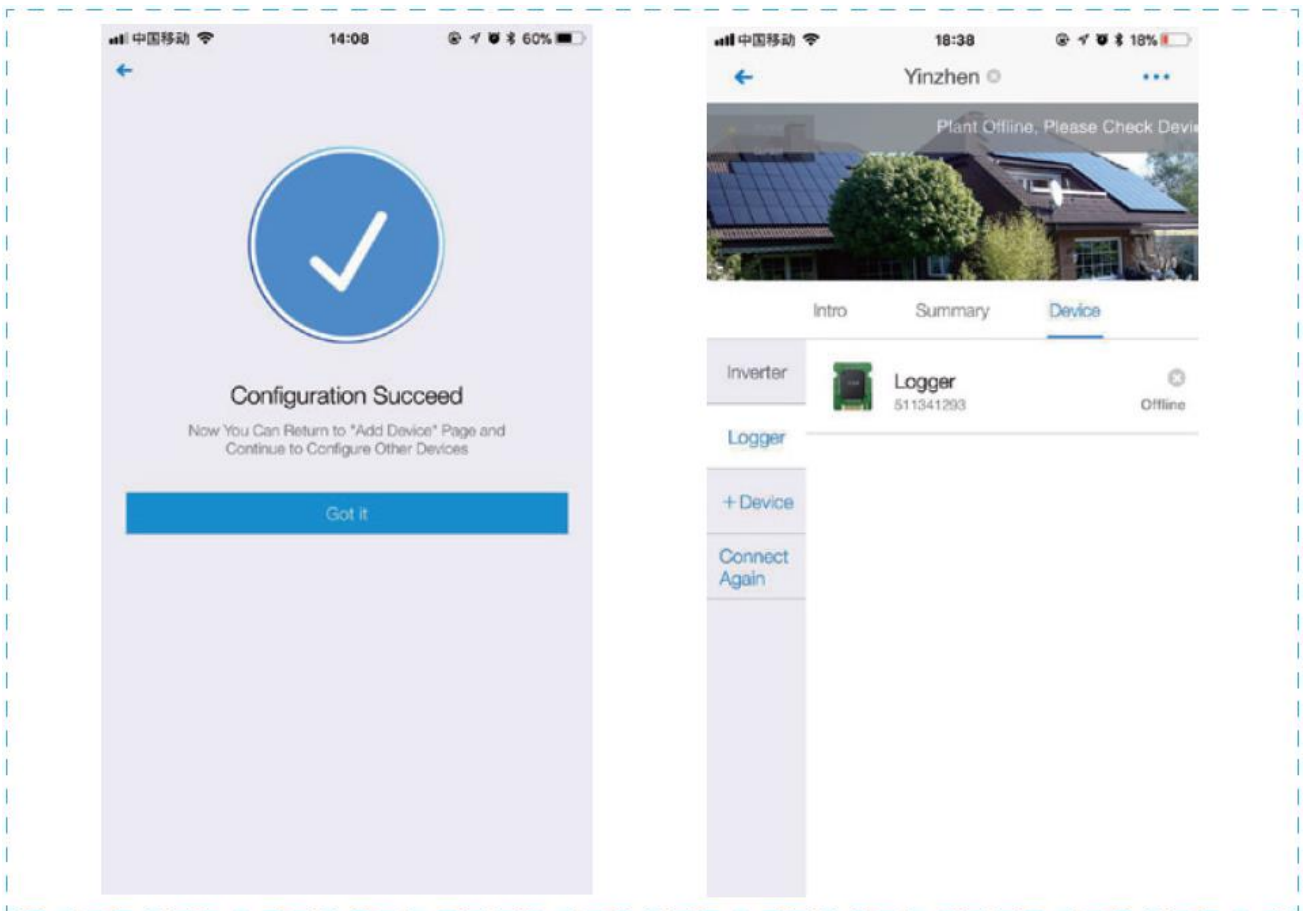

Configuration (for iOS user)

- 1) APP will automatically get your Wi-Fi network, so you need to enter your Wi-Fi password to continue the configuration, if the network is not accurate, select [Switch network], then find or manually enter the network ID.

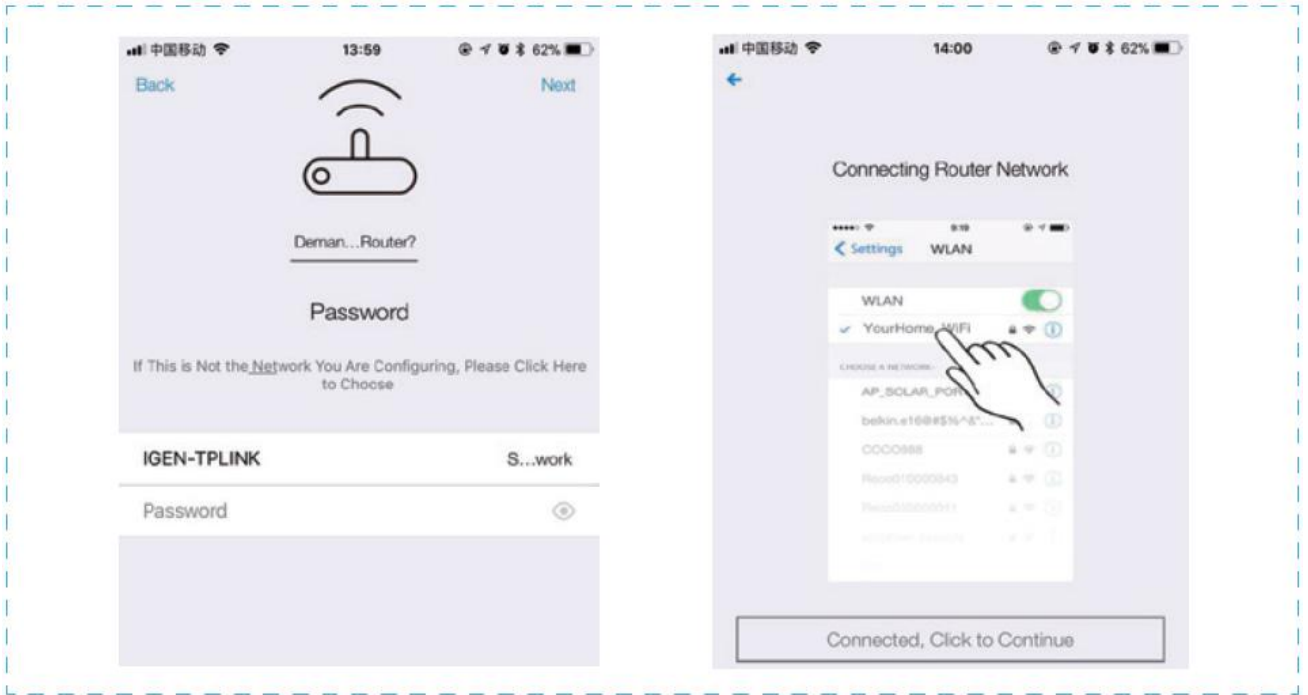

- 2) Go to iPhone's [Network Settings] interface, and select the stick logger's network AP_XXXXX(S/N), Then return to Soluna APP, the stick logger will start to configure.

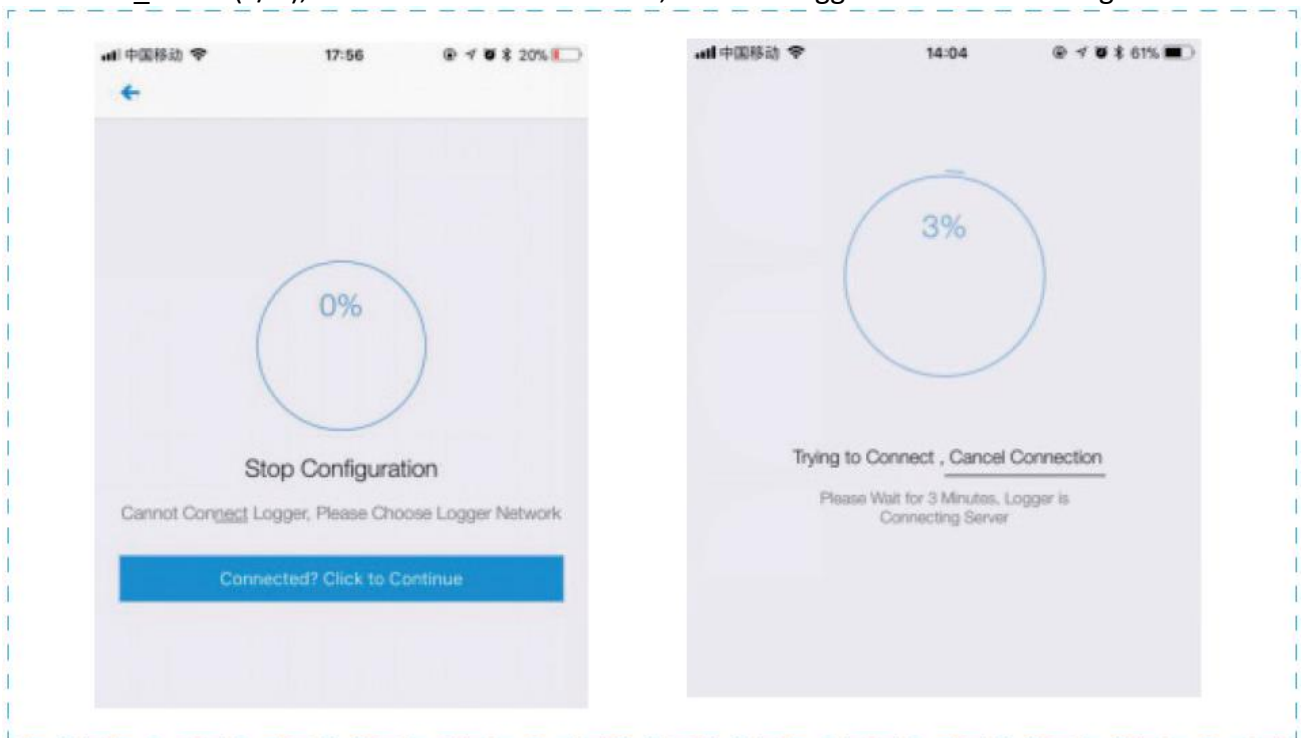

Notice:

If it is unable to find an AP_XXXXX(S/N) in wireless network list, please make sure to shorten the distance between Wi-Fi routers and stick Logger to under 10 meters, the connection or setting may appear problem, if you have repeat the above steps and Still cannot find the AP_XXXXX, please follow the logger Manual for troubleshooting or contact our customer Centre.

- 3) It normally takes 3~5 minutes to configure successfully, then, you can go back to tab [+Device] and click [+Device] to add more devices

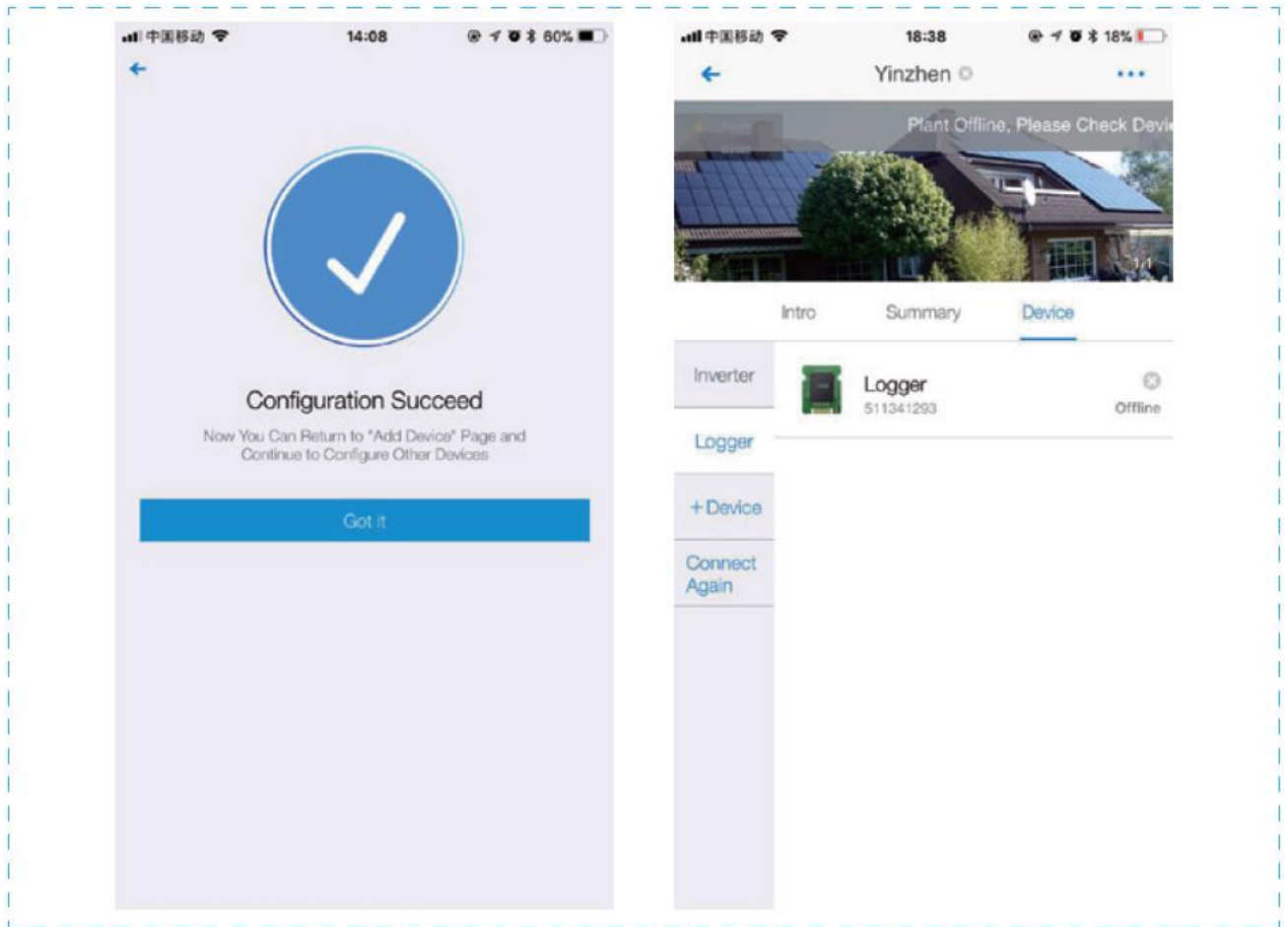

If the configuration fails, the reasons may be;

1. Router password is wrong, please click [Retry] and check the password
2. The router's network signal is weak and the logger is too far away from the router, put the router closer to the logger.
3. Click too fast during the Logger's AP connection. Please wait a few seconds and then jump to the configuration after Logger's AP is connected

If you meet following situations, please reconfigure logger network:

1. Charge router
2. Change Wi-Fi password
3. Change router's SSID
4. Enterprise routers may restrict Wi-Fi connectivity.

Contact us

If any questions, please contact us.

DLG Energy (Shanghai) Co., Ltd

Soluna

Address: No.3492 Jinqian Road, Shanghai, China 201406

Tel: +86-21-57475835

Email: sales@solunabattery.com

Web: www.solunabattery.com
